

---

# USER'S MANUAL

## Model DRC-91CA

### Temperature Controller

#### Obsolete Notice:

This manual describes an obsolete Lake Shore product. This manual is a copy from our archives and may not exactly match your instrument. Lake Shore assumes no responsibility for this manual matching your exact hardware revision or operational procedures. Lake Shore is not responsible for any repairs made to the instrument based on information from this manual.



Lake Shore Cryotronics, Inc.  
575 McCorkle Blvd.  
Westerville, Ohio 43082-8888 USA

Internet Addresses:  
[sales@lakeshore.com](mailto:sales@lakeshore.com)  
[service@lakeshore.com](mailto:service@lakeshore.com)

Visit Our Website:  
[www.lakeshore.com](http://www.lakeshore.com)

Fax: (614) 891-1392  
Telephone: (614) 891-2243

Methods and apparatus disclosed and described herein have been developed solely on company funds of Lake Shore Cryotronics, Inc. No government or other contractual support or relationship whatsoever has existed which in any way affects or mitigates proprietary rights of Lake Shore Cryotronics, Inc. in these developments. Methods and apparatus disclosed herein may be subject to U.S. Patents existing or applied for. Lake Shore Cryotronics, Inc. reserves the right to add, improve, modify, or withdraw functions, design modifications, or products at any time without notice. Lake Shore shall not be liable for errors contained herein or for incidental or consequential damages in connection with furnishing, performance, or use of this material.

# **Your Model DRC-91CA has been configured as follows:**

Serial Number: \_\_\_\_\_

Main Software Version: \_\_\_\_\_

Sales Order Number: \_\_\_\_\_

## **Input Cards:**

		<u>Input A</u>	<u>Input B</u>
9210-3	Standard 3 volt Configuration	<input type="checkbox"/>	<input type="checkbox"/>
9210-6	6 volt Diode Configuration	<input type="checkbox"/>	<input type="checkbox"/>
9215-15	Standard 15 Nanofarad Capacitance	<input type="checkbox"/>	<input type="checkbox"/>
9215-150	150 Nanofarad Configuration	<input type="checkbox"/>	<input type="checkbox"/>
9220-3	Standard 3 volt Configuration	<input type="checkbox"/>	<input type="checkbox"/>
9220-6	6 volt Diode Configuration	<input type="checkbox"/>	<input type="checkbox"/>
9220-P2	100 ohm Platinum Conversion Module	<input type="checkbox"/>	<input type="checkbox"/>
9220-P3	1000 ohm Platinum Conversion Module	<input type="checkbox"/>	<input type="checkbox"/>
9220-R1	27 ohm Rh-Fe Conversion Module	<input type="checkbox"/>	<input type="checkbox"/>
9305	Thermocouple	<input type="checkbox"/>	<input type="checkbox"/>
9317C	Ultra-low (0.3K) Germanium	<input type="checkbox"/>	<input type="checkbox"/>
9318C	Germanium/Carbon Glass	<input type="checkbox"/>	<input type="checkbox"/>
No Input Card		<input type="checkbox"/>	<input type="checkbox"/>

## **Option Cards:**

8223	RS-232C Interface	<input type="checkbox"/>
8225	Analog Output Interface	<input type="checkbox"/>
8229	Scanner	<input type="checkbox"/>
High Resolution Setpoint		<input type="checkbox"/>

## **Output Power Option:**

W50	<input type="checkbox"/>
W60	<input type="checkbox"/>

## **Precision Option:**

8001	<input type="checkbox"/>
------	--------------------------

### **LAKE SHORE CRYOTRONICS, INC. LIMITED WARRANTY**

Lake Shore Cryotronics, Inc., the manufacturer, warrants this product for a period of twelve (12) months (six months for sensors) from the date of shipment. During the warranty period, under authorized return of instruments or component parts to Lake Shore freight prepaid, the company will repair, or at its option replace, any part found to be defective in material or workmanship, without charge to the Owner for parts, service labor or associated customary shipping cost. Replacement or repaired parts will be warranted for only the unexpired portion of the original warranty.

This warranty is limited to Lake Shore products purchased and installed in the United States. This same protection will extend to any subsequent owner during the warranty period. It does not apply to damage caused by accident, misuse, fire, flood or acts of God, or from failure to properly install, operate or maintain the product in accordance with the printed instructions provided.

THIS WARRANTY IS IN LIEU OF ANY OTHER WARRANTIES, EXPRESSED OR IMPLIED, INCLUDING MERCHANTABILITY OR FITNESS FOR A PARTICULAR PURPOSE, WHICH ARE EXPRESSLY EXCLUDED. THE OWNER AGREES THAT LAKE SHORE'S LIABILITY WITH RESPECT TO THIS PRODUCT SHALL BE SET FORTH IN THIS WARRANTY, AND INCIDENTAL OR CONSEQUENTIAL DAMAGES ARE EXPRESSLY EXCLUDED.

## ***Safety Summary***

The following general safety precautions must be observed during all phases of operation, service, and repair of this instrument. Failure to comply with these precautions or with specific warnings elsewhere in this manual violates safety standards of design, manufacture, and intended use of the instrument. Lake Shore Cryotronics, Inc. assumes no liability for the customer's failure to comply with these requirements.

### ***Ground The Instrument***

To minimize shock hazard, the instrument chassis and cabinet must be connected to an electrical ground. The instrument is equipped with a three-conductor ac power cable. The power cable must either be plugged into an approved three-contact electrical outlet or used with a three-contact adapter with the grounding wire (green) firmly connected to an electrical ground (safety ground) at the power outlet. The power jack and mating plug of the power cable meet Underwriters Laboratories (UL) and International Electrotechnical Commission (IEC) safety standards.

### ***Do Not Operate In An Explosive Atmosphere***

Do not operate the instrument in the presence of flammable gases or fumes. Operation of any electrical instrument in such an environment constitutes a definite safety hazard.

### ***Keep Away From Live Circuits***

Operating personnel must not remove instrument covers. Component replacement and internal adjustments must be made by qualified maintenance personnel. Do not replace components with power cable connected. To avoid injuries, always disconnect power and discharge circuits before touching them.

### ***Do Not Substitute Parts Or Modify Instrument***

Because of the danger of introducing additional hazards, do not install substitute parts or perform any unauthorized modification to the instrument. Return the instrument to an authorized Lake Shore Cryotronics, Inc. representative for service and repair to ensure that safety features are maintained.

### ***Dangerous Procedure Warnings***

A WARNING heading precedes potentially dangerous procedures throughout this manual. Instructions in the warnings must be followed.

## Safety Symbols



Instruction manual symbol: the product will be marked with this symbol in order to protect against damage to the instrument.



Indicates dangerous voltage (terminals fed from the interior by voltage exceeding 1000 volts must be so marked).

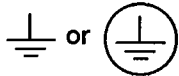

Protective conductor terminal. For protection against electrical shock in case of a fault. Used with field wiring terminals to indicate the terminal which must be connected to ground before operating equipment.



Low-noise or noiseless, clean ground (earth) terminal. Used for a signal common, as well as providing protection against electrical shock in case of a fault. A terminal marked with this symbol must be connected to ground in the manner described in the installation (operating) manual, and before operating equipment.

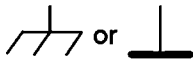

Frame or chassis terminal. A connection to the frame (chassis) of the equipment which normally includes all exposed metal structures.



Alternating current (power line).



Direct current (power line).



Alternating or direct current (power line).

The **WARNING** sign denotes a hazard. It calls attention to a procedure, practice, condition or the like, which, if not correctly performed or adhered to, could result in injury or death to personnel.

The **Caution** sign denotes a hazard. It calls attention to an operating procedure, practice, or the like which, if not correctly performed or adhered to, could result in damage to or destruction of part or all of the product.

The **Note** sign denotes important information. It calls attention to procedure, practice, condition or the like, which is essential to highlight.

# TABLE OF CONTENTS

---

## **1 INTRODUCING THE MODEL DRC-91CA TEMPERATURE CONTROLLER**

<i>What is the Model DRC-91CA</i> .....	1-1
<i>More About the Model DRC-91CA</i> .....	1-2
<i>Sensors</i>	
<i>Precision Options</i>	
<i>Memory</i>	
<i>Sensor Input Cards</i>	
<i>Control Setpoint</i>	
<i>Heater Power Output</i>	
<i>Interfaces</i>	
<i>Option Cards</i>	
<i>Specifications</i> .....	1-5
<i>Front and Rear Panel Graphic</i> .....	1-6

## **2 INSTALLING THE MODEL DRC-91CA TEMPERATURE CONTROLLER**

<i>Environmental Requirements</i> .....	2-2
<i>Operating Temperature</i>	
<i>Power Requirements</i> .....	2-2
<i>Grounding and Shielding</i> .....	2-2
<i>Heater Setup</i> .....	2-3
<i>Heater Connection</i>	
<i>Heater Output Ranges</i>	
<i>MAX Range Limit</i>	
<i>Heater Display</i>	
<i>Sensor Input Connection</i> .....	2-4
<i>Diode/Platinum</i>	
<i>Sensor Output Monitors</i> .....	2-5
<i>Installation Of Software and Input/Option Cards</i> .....	2-5
<i>Bench Use</i> .....	2-6
<i>Rack Mounting</i> .....	2-6

# TABLE OF CONTENTS

---

<b>3</b>	<b>OPERATING THE MODEL DRC-91CA TEMPERATURE CONTROLLER</b>	
	<i>Power Up Sequence</i> .....	3-2
	<i>Power Up Errors</i>	
	<i>Power Up Status Switch</i>	
	<i>Display Sensor</i> .....	3-4
	<i>Selecting Display Sensor Input Channel</i>	
	<i>Selecting Display Sensor Units</i>	
	<i>Display Resolution</i>	
	<i>Sample Input Errors</i>	
	<i>Control Sensor</i> .....	3-5
	<i>Selecting Control Sensor Input Channel</i>	
	<i>Selecting Control Sensor Units</i>	
	<i>Display Resolution</i>	
	<i>The SCAN Function</i> .....	3-6
	<i>The Scan Dwell Time</i>	
	<i>Temperature Compensation</i>	
	<i>Filter Function</i> .....	3-6
	<i>Control Parameters</i> .....	3-7
	<i>Setpoint</i>	
	<i>Gain</i>	
	<i>Rate</i>	
	<i>Reset</i>	
	<i>Heater Range</i>	
	<i>How to Manually Set PID Parameters</i> .....	3-8
	<i>Sensor ID Switches</i> .....	3-9
	<i>Sensor Curve Selection</i> .....	3-10
	<i>Normal Curve Selection With Curves Numbered 00 Through 15</i>	
	<i>Operation With Curve Numbers Higher Than 15</i>	
	<i>Sensor Curve Assignment With 8229 Scanner Option</i>	
	<i>Sensor Curve Assignment With External Scanners</i>	

# TABLE OF CONTENTS

---

<b>4</b>	<b>REMOTE OPERATION OF THE MODEL DRC-91CA TEMPERATURE CONTROLLER</b>	
	IEEE-488 Interface .....	4-2
	General IEEE Specifications.....	4-2
	Interface Capabilities .....	4-2
	DRC-91CA IEEE-488 Address Switch .....	4-3
	Terminating Characters	
	TALKER and/or LISTENER Configuration	
	Setting the DRC-91CA IEEE Address Switch	
	IEEE-488 Commands .....	4-6
	Bus Control Commands	
	Device Specific Commands	
	Additional Notes on Commands	
	Serial Interface .....	4-9
	Interface Commands .....	4-10
	Thermometry Commands.....	4-13
	Scan Commands .....	4-18
	Control Commands.....	4-21
	Status Registers .....	4-25
	Status Byte Register and Service Request Enable Register	
	Curve Commands.....	4-29
	Sample Programs .....	4-34
<b>5</b>	<b>MODEL DRC-91CA TEMPERATURE CONTROLLER INPUT/OPTION CARDS</b>	
	9210 Diode Input Card .....	5-2
	Description	
	Installation	
	Operation	
	Calibration	
	Sensor Curve Information	
	9220 Diode and Platinum Input Card .....	5-5
	Description	
	Installation	
	Operation	
	Calibration	
	Sensor Curve Information	

# TABLE OF CONTENTS

---

<b>9317C/9318C Resistance Input Card</b> .....	<b>5-8</b>
<i>Description</i>	
<i>Installation</i>	
<i>Operation</i>	
<i>Calibration</i>	
<i>Sensor Curve Information</i>	
<b>9215 Capacitance Input Card</b> .....	<b>5-16</b>
<i>Description</i>	
<i>Notes on CS-501 Capacitance Sensors</i>	
<i>Installation</i>	
<i>Sensor Connections</i>	
<i>Selection of the Sign of the Temperature Coefficient</i>	
<i>Operation</i>	
<i>Calibration</i>	
<b>9305 Thermocouple Input Card</b> .....	<b>5-23</b>
<i>Description</i>	
<i>Installation</i>	
<i>Sensor Attachment</i>	
<i>Types of Thermocouples</i>	
<i>Operation</i>	
<i>Calibration</i>	
<i>Sensor Curve Information</i>	
<i>Option Compatibility</i>	
<b>8223 RS-232C Interface Option Card</b> .....	<b>5-32</b>
<i>Description</i>	
<i>Configuration of Dip Switches</i>	
<i>Installation</i>	
<i>Operation</i>	
<i>Interfacing Examples</i>	
<b>8225 Analog Output Option Card</b> .....	<b>5-42</b>
<i>Description</i>	
<i>Installation</i>	
<i>Operation</i>	
<i>Calibration</i>	
<b>8229 Scanner Conversion Option Card</b> .....	<b>5-45</b>
<i>Description</i>	
<i>Installation</i>	
<i>Operation</i>	
<i>Curve Selection</i>	

## **APPENDICES**

- A**    *Inspection*
- B**    *Service and Calibration*
- C**    *Error Code Summary*
- D**    *Curve Tables*
- E**    *Application Notes*



# INTRODUCING THE MODEL DRC-91CA TEMPERATURE CONTROLLER

# 1

## **What is the Model DRC-91CA?**

The DRC-91CA Temperature Controller combines microprocessor based convenience with true analog control. The controller features:

- **Three Term (PID) Real-Time Analog Control**
- **Two sensor input card slots**
- **Interchangeable input cards for: silicon diodes, GaAlAs diodes, platinum and rhodium-iron RTDs, germanium, carbon-glass and carbon composite resistors, thermistors, capacitance sensors and thermocouples.**
- **IEEE-488 interface**
- **Precision options which improve sensor display accuracy to between 1 and 100mK, depending on sensor type and temperature range selection.**
- **Optional scanner which adds four sensor inputs expanding usage to six temperature sensors.**
- **Optional analog output**
- **Optional RS-232C card**

### **NOTE**

*If you are unpacking a new Model DRC-91CA Temperature Controller, you will want to refer to the inspection suggestions provided in Appendix A.*

# INTRODUCING THE MODEL DRC-91CA TEMPERATURE CONTROLLER

## More About the Model DRC-91CA

### Sensors

The DRC-91CA is one of the most versatile instruments of its kind on the market. You can change sensor types by simply changing sensor cards or their configuration. Refer to *LakeShore's Temperature Sensor Guide* for sensor details.

### Precision Options

For best precision, individual sensors should be used with the 8001 Precision Calibration Option. This option programs the instrument with calibration data for an individual sensor. The algorithm within the instrument interpolates between data points to an accuracy which exceeds 25mK over the entire temperature range of the Precision Option. Therefore, the overall system error, and that of the calibration itself, is reduced to a minimum. *LakeShore* calibrations are typically better than 20mK below 28K for diode sensors. See the *LakeShore Low Temperature Calibration Service Brochure* or *Temperature Sensor Guide* for additional discussion of calibration accuracy.

There are three types of Precision Options available for the DRC-91CA.

#### **The Model 8000 Precision Option**

The Model 8000 Precision Option generates the data table from a Lake Shore calibrated sensor. The upper limit of data points is 97, with a typical calibration ranging between 30 and 40 points (depending on sensor type and temperature range for the calibration). The data and accuracy of the fit is supplied to the user as a separate document. This information can then be entered via the computer interface.

#### **NOTE**

*Lake Shore recommends that a Precision Option be ordered for calibrated Germanium, TG-120 and Carbon Glass sensors if you want the DRC-91CA to display temperature.*

If requested, the 8000 Precision Option also includes the data on a disk and a program for the user to enter it into the controller from an IBM compatible PC .

#### **The Model 8001 Precision Option**

Lake Shore can also generate custom sensor response curves from the individual sensor calibrations as indicated above and store them in the DRC-91CA via the 8001 Precision Option prior to shipment. The data and accuracy of the fit is then supplied in a plastic holder at the end of this manual.

#### **The Model 8002-05 Precision Option**

The 8002 Precision Option is used when the customer already owns a DRC-91CA and wants new sensor calibration data stored in the instrument. Lake Shore stores the calibration data in a battery back-up, non-volatile RAM chip and sends the programmed chip to the customer. The chip is then installed in the DRC-91CA by the customer. If the DRC-91CA already has Precision Options installed, please indicate the instrument serial number and the sensor serial numbers when ordering and Lake Shore will install those curves with the new Precision Option.

# INTRODUCING THE MODEL DRC-91CA TEMPERATURE CONTROLLER

---

## **Memory**

The ample memory space provided in the Model DRC-91CA allows several sensor response curves to be stored in the instrument. The data for calibrated sensors can be stored in the instrument as an 8001 Precision Option at the factory or by the customer via the IEEE-488 or RS-232 interface option. With the standard response curve format of 31 data points, there is room for 20 curves.

## **Sensor Input Cards**

The Model DRC-91CA can be used with either one or two input cards. The Sensor Input Cards that are available allow the DRC-91CA to be used with almost any type of cryogenic sensor.

Sensor Input Cards provide sensor excitation signals and read the sensor response. They also digitize the signal which is used by the microprocessor to calculate temperature. All of the DRC-91CA Sensor Input Cards can be used on either Input A or Input B. The Sensor Input Cards available and a brief description are listed below.

**9210 Diode** - Accommodates Silicon Diode sensors and Gallium Aluminum Arsenide Diode sensors.

**9220 Platinum and Diode Sensors** - Accommodates either of the Diodes above or positive temperature coefficient sensors Platinum and Rhodium-iron.

**9215 Capacitance** - Accommodates Capacitance Sensors.

**9305 Thermocouple** - Accommodates Thermocouple Sensors.

**9317C/9318C Germanium and Carbon Glass Resistors** - Can be used with Germanium, Carbon Glass or Carbon Resistors or any other negative coefficient resistors.

A complete and detailed discussion on the Sensor Input Cards is in Section 5 of this manual. Please refer there for information on your particular Sensor Input Card(s).

### **One Sensor Input Card**

When only one sensor input card is present, it occupies the Sensor Input Card A slot and is connected to the Sensor A input of the controller.

### **Two Sensor Input Cards**

When two sensor input cards are present in the unit, the card that occupies the Sensor Input Card A slot is routed to the Sensor A input and the card that occupies the Sensor Input Card B slot is routed to the Sensor B input. Both sensors are energized at all times.

# **INTRODUCING THE MODEL DRC-91CA TEMPERATURE CONTROLLER**

---

## **Control Setpoint**

Setting the control setpoint is achieved via the front panel keypad or over the computer interface. The lower display is used for displaying the control setpoint.

## **Heater Power Output**

Heater power output of the Model DRC-91CA Temperature Controller is a variable DC current source for quiet, stable control. It sources 25 watts with a 25 $\Omega$  heater, 50 and 60 watt options are available. The digital display on the front panel reflects percentage of full scale output current or power in the range selected. Thus, the user can conveniently monitor heater power applied to the system. To accommodate systems which require lower heater power, the maximum output power can be attenuated in three steps of a decade each.

## **Interfaces**

The IEEE-488 interface is standard in the DRC-91CA. The interfaces can be used to remotely control most front and rear panel functions as well as output display data and instrument status.

## **Option Cards**

A complete and detailed discussion on Option Cards is in Section 5 of this manual. Please refer there for information on your particular Option Card(s).

All three options are field installable.

**8223 RS-232C Interface** - Provides an interface with an external computer via RS-232.

**8225 Analog Output** - Provides an analog output proportional to the kelvin temperature of the display or control sensor. The purpose is to record the sensor temperature either with a strip chart recorder or other similar device.

**8229 Scanner Option** - Provides four additional sensor inputs to Input A. They are designated A1 through A4.

# INTRODUCING THE MODEL DRC-91CA TEMPERATURE CONTROLLER

## Specifications

<b>Inputs:</b>	Mainframe accommodates up to two Input Cards. Card types (i.e. Sensor types) can be mixed. If only one card is utilized, the same Sensor is used for control and display. ( <i>Order Input Cards and Sensors separately.</i> )
<b>Display:</b>	Five-digit LED readout with selectable resolution and units.
<b>Response Time (Electronics):</b>	Less than one second to rated accuracy without an instantaneous step change in temperature.
<b>Temperature Control</b>	
<b>Setpoint Resolution:</b>	Control units can be selected independent of display sensor units. Setpoint resolution depends on units selected.
<b>Temperature:</b>	0.1
<b>Voltage:</b>	to 100 $\mu$ V for diodes, 1 $\mu$ V for thermocouples
<b>Resistance:</b>	refer to the Sensor Input Card Section of this manual
<b>Capacitance:</b>	refer to Sensor Input Card Section of this manual
<b>Control Mode:</b>	Proportional (GAIN), integral (RESET), and derivative (RATE). Real-time analog control.
<b>Heater Output:</b>	25 watts (1A, 25V into 25 ohms) standard. ( <i>See below for optional configuration.</i> )
<b>Heater Output Monitor:</b>	Displays heater output as a percentage of maximum power or current available on range selected. 1% resolution.
<b>Control Stability:</b>	Depends upon Sensor type and sensitivity. To within $\pm 0.001K$ below 30K, $\pm 0.005K$ above 30K, in a properly designed system using a Diode sensor.
<b>Control Sensor:</b>	Either A or B input, if present. Switched on rear panel. Can be independent of Display Sensor.
<b>General</b>	
<b>Remote Interface:</b>	IEEE-488 standard. RS-232C field installable option. See below.
<b>Dimensions:</b>	432mm wide x 102mm high x 330mm deep (17" x 4" x 13"). Style L, full-rack package.
<b>Weight:</b>	(Net) 8kg (17.5 lb.)
<b>Power:</b>	Selectable for 100, 120, 220, 240 volts, +5%/-10%, 50/60 Hz, 75 watts.
<b>Options and Accessories</b>	
<b>8001 Precision Option:</b>	Custom programming of specific Sensor calibrations curve(s) at factory. Provides highest degree of temperature readout accuracy.
<b>8223 RS-232C Interface:</b>	Provides remote operation of the same commands as the IEEE-488.
<b>8225 Analog Output:</b>	Provides analog output proportional to kelvin temperature (10mV/K) with < 10 ohms output resistance.
<b>8229 Scanner Input Option:</b>	Adds four additional channels to the "A" input. Scans up to six sensors with programmable dwell times.
<b>8271-21 Sensor/Heater Cable:</b>	10 ft. long
<b>8271-22 Sensor/Heater/Output Cable:</b>	10 ft. long
<b>8072 IEEE-488 Interconnect Cable:</b>	one meter long
<b>W50:</b>	50 watt (1.0A, 50V) output for 50 ohm heater
<b>W60:</b>	60 watt (1.55A, 39V) output for 25 ohm heater
<b>HTR-50:</b>	50 ohm cartridge heater, 50W, 1/4" dia x 1" long
<b>HTR-25:</b>	25 ohm cartridge heater, 25W, 3/8" dia x 1" long
<b>RM-3F:</b>	Rack Ears for DRC-91CA case
<b>RM-3F-H:</b>	Rack Ears with handles for DRC-91CA case
<b>Input Card Options:</b>	See Section 5 of manual.

# INTRODUCING THE MODEL DRC-91CA TEMPERATURE CONTROLLER

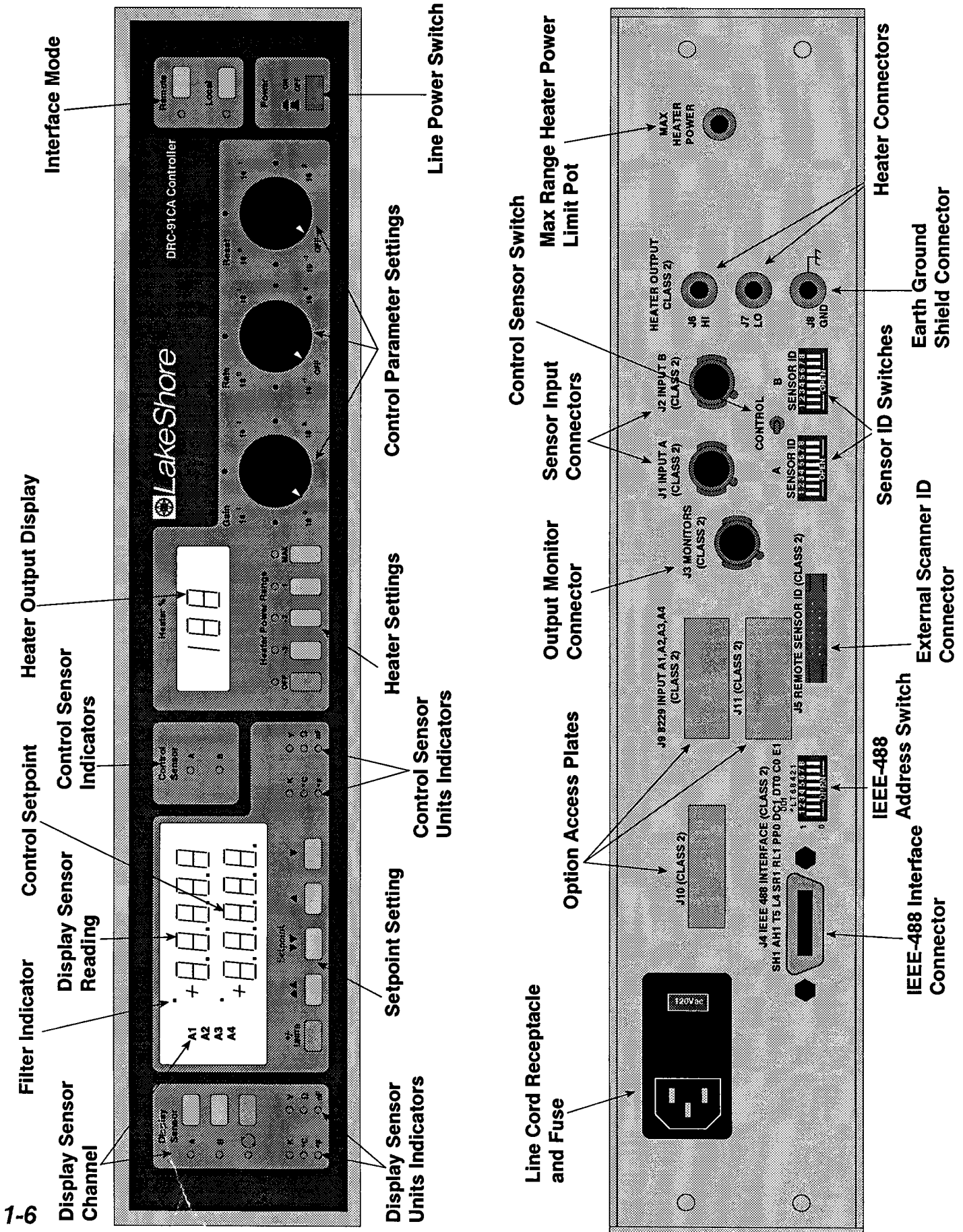

# **INSTALLING THE MODEL DRC-91CA TEMPERATURE CONTROLLER**

---

# **2**

In this section, you will learn how to install your Model DRC-91CA. The main topics covered are;

- ***Environmental Requirements***
- ***Power Requirements***
- ***Grounding and Shielding***
- ***Heater Setup***
- ***Sensor Input Connections***
- ***Sensor Output Monitors***
- ***Installation of Software and Input/Option Cards***
- ***Bench Use***
- ***Rack Mounting Instructions***

# INSTALLING THE MODEL DRC-91CA TEMPERATURE CONTROLLER

## Environmental Requirements

### Operating Temperature

The DRC-91CA is for laboratory use. In order to meet and maintain specifications, this unit should be operated at an ambient temperature range of 23°C  $\pm$ 5°C. The unit may be operated within the range of 15-35°C with reduced accuracy.

**WARNING** To prevent electrical fire or shock hazards, do not expose this instrument to rain or excess moisture.

## Power Requirements

The Model DRC-91CA requires a power source of 100, 120, 220 or 240 VAC (+5%, -10%), 50 to 60 Hz single phase.

**CAUTION** Verify that the AC Line Voltage Selection Wheel located on the rear panel of the Model DRC-91CA is set to the available AC line voltage and that the proper fuse is installed before inserting the power cord and turning on the instrument. (To change voltage configuration see Appendix B.)

Line Voltage Selection

Select	Range (VAC)	Fuse(A)
100	90-105	2 - SB
120	108-126	2 - SB
220	198-231	1 - SB
240	216-252	1 - SB

## Grounding and Shielding

To protect operating personnel, the National Electrical Manufacturer's Association (NEMA) recommends, and some local codes require, instrument panels and cabinets be grounded. This instrument is equipped with a three-conductor power cable which, when plugged into an appropriate receptacle, grounds the instrument.

Grounding and shielding of signal lines are major concerns when setting up any precision instrument or system. The DRC-91CA has included ground isolation to reduce noise and improve accuracy. Improper grounding of sensor leads and shields can defeat this feature.

Digital logic in the Model DRC-91CA is tied directly to earth ground for interface communication. The sensor input and the heater output are isolated from earth ground to keep digital noise out of the analog circuits. Try to keep these signals isolated from earth ground whenever possible. If it is impossible to isolate all analog signals, never ground them in more than one place.

Shield sensor cables whenever possible. Attach the shields to the shield pin provided in the connector.

**NOTE** Do not attach the shield to earth ground at the sensor end.



# INSTALLING THE MODEL DRC-91CA TEMPERATURE CONTROLLER

## Heater Setup

The heater output is a 1 amp current drive and does not have to be fused. The DRC-91CA is designed to power a 25 ohm heater for maximum heater output. If a smaller resistance is used, the maximum power output will be reduced (e.g., 10 ohms yields 10 watts). A larger heater resistance may also be used but will result in a lower maximum power output. For example, on the MAX scale, the output compliance voltage is 25 volts so that a 100 ohm heater resistance allows a maximum power output of 6.25 watts [(25V)<sup>2</sup>/100Ω]. The W50 option provides 1A @ 50V compliance and W60 gives 1.55A @ 39V compliance.

If a heater resistance is 50% less than the specified value, add an additional resistance in series with the heater load so that the total resistance connected between Hi and Lo terminals equals the desired value.

## Heater Connection

The heater output of the DRC-91CA is brought out the back panel as a Dual Banana Jack. Current is driven from the HEATER (HI) connection to the HEATER (LO) connection. A resistive heater load of 25 ohms should be connected between these two points.

Within a cryostat, 30 gauge stranded copper lead wire (ND-30) is recommended for connection to the heater. For quiet heater operation, HEATER (LO) should be electrically isolated from earth ground. Earth ground is provided on the rear panel for shielding purposes only!

The heater output leads should also be electrically isolated from the sensor grounds to reduce the heater's current effect on the sensor input signal. The heater leads should not run coincident with the sensor leads due to the possibility of capacitive pick-up between the two sets of leads. (NOTE: If the heater leads must be close to the sensor leads, wind (twist) them in such a manner that they cross each other at ninety degrees.)

## Heater Output Ranges

The heater current output of the DRC-91CA is capable of 1A full scale on the HIGH range. If the system or heater being used is not capable of carrying 1A of current, select a lower range for approximate decade reductions in power. (See Section 3 for heater operation.)

Range	Standard	W50 Option	W60 Option
MAX	1A = 25W @ 25Ω	1A = 50W @ 50Ω	1.55A = 60W @ 25Ω
-1	0.3A = 2.5W @ 25Ω	0.3A = 5W @ 50Ω	0.5A = 6W @ 25Ω
-2	0.1A = 0.25W @ 25Ω	0.1A = 0.5W @ 50Ω	0.15A = 0.6W @ 25Ω
-3	0.03A = 0.025W @ 25Ω	0.03A = 0.05W @ 50Ω	0.05A = 0.06W @ 25Ω

## Max Range Limit

The maximum power range can be limited from 35% to 100% of its maximum value by adjusting the MAX HEATER POWER Limiting Pot on the rear panel.

## Heater Display

The heater output display is either a percentage of maximum power for the range or a percentage of maximum current. The unit is shipped reading a percentage of maximum power. It can be changed by switching Dip Switch 1 of S4 inside the unit. S4 is located in the rear center on the main board. See page 2-5 (Installation of Software and Input/Option Cards) for proper procedure on removing enclosure and calibration cover.

# INSTALLING THE MODEL DRC-91CA TEMPERATURE CONTROLLER

## Sensor Input Connections

### Diode/Platinum Connection

The DRC-91CA has two rear panel 5-pin input connectors for diode and resistance sensors. The lead connection definition for the sensor is given in Table 2-1 and is shown below.

Figure 2-1  
Sensor Connections

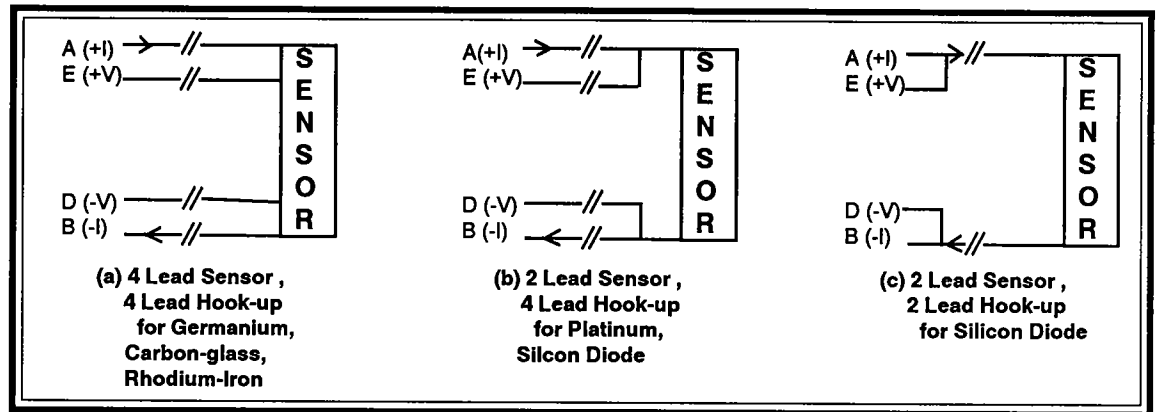

Table 2-1. Input Connections for J1 and J2

Terminal	Description
A	+ Current Out
B	- Current Out
D	- Voltage Sense
E	+ Voltage Sense
H	Shield

The use of a four wire connection (Figure 2-1 a,b) is highly recommended for two lead resistive elements and diodes to avoid introducing IR drops in the voltage sensing pair which translates into a temperature measurement error.

#### NOTE

An alternate two line wiring method (Terminals I and V shorted together) may be used for the DT-470 and TG-120 series diodes in less critical applications where lead resistance is small and small readout errors can be tolerated (Figure 2-1 {c}). Measurement errors due to lead resistance for a two lead hook-up can be calculated using;  $T = IR/[dV/dT]$  where I is 10 microamperes, R is the total lead resistance; dV/dT is the diode sensitivity and T is the measurement error. For example, R = 250 with dV/dT = 2.5 mV/K results in a temperature error of 1 kelvin. Two wire connections are not recommended for platinum.

The Lake Shore Cryotronics, Inc. QUAD-LEAD™ 36 Gauge Cryogenic wire is ideal for connections to the sensor since the four leads are run together and color-coded. The wire is Phosphor Bronze with a Formvar insulation and Butryral bonding between the four leads. Color coding is red, green, clear and blue on the four leads which makes it extremely easy to determine one wire from another. For this and other accessories, refer to LakeShore's Cryogenic Accessories Catalog in the back of this manual.

# INSTALLING THE MODEL DRC-91CA TEMPERATURE CONTROLLER

## Sensor Output Monitors

Buffered voltage outputs for both Sensor Input A and B are available on the J3 connector on the rear panel of the instrument. The voltage from the Model 8225 Analog Output Option is present on this connector also. The connector pin assignments are given in the table below.

Table 2-2. J3 Monitors Connections

Terminal	Description
A	Voltage Output (Input A)
B	Voltage Output (Input B)
C	10 mV/K Analog Output
D	Ground for Analog Output
E	Setpoint Output
F	Ground (A + B, Setpoint)
H	(Optional Shield)

## Installation of Software and Input/Option Cards

It may be necessary for you to get inside the unit to change or install current software or input/option cards. To do so, simply follow the steps outlined below.

**WARNING** To prevent shock hazard, turn off the instrument and disconnect it from AC line power and all test equipment before removing cover.

1. Set the POWER switch to off and disconnect the power cord from the unit.
2. Remove the 6 screws on the sides of the top enclosure half and lift the cover off.
3. The calibration cover will now be seen.

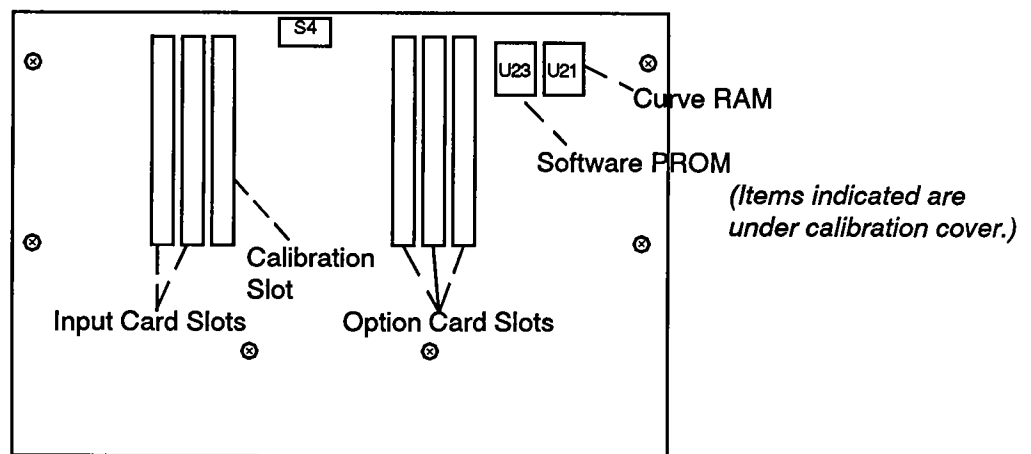

FRONT OF UNIT

4. To calibrate the unit, the user would stop here.
5. Remove the calibration cover by taking out the six screws on the top of the cover (indicated in the drawing above by ⊗). Also, remove the two screws in the center of the rear panel of the instrument located near the top. Lift the cover off.
6. To replace specific cards, refer to the Input/Option card section. Follow the instructions accompanying your software PROMs to replace them.

## **INSTALLING THE MODEL DRC-91CA TEMPERATURE CONTROLLER**

---

### ***Bench Use***

The DRC-91CA is shipped with plastic tilt stand feet installed and is ready for use as a bench instrument. The front of the instrument may be elevated by extending the tilt stands. This provides convenient operation and viewing.

### ***Rack Mounting***

The DRC-91CA can be installed in a standard 19 inch instrument rack by using the optional RM-3F (or RM-3F-H with handles) Rack Mounting Kit.

# **OPERATING THE MODEL DRC-91CA TEMPERATURE CONTROLLER**

---

# **3**

In this section, you will learn how to operate the Model DRC-91CA. The main topics covered are;

- ***Power Up Sequence***
- ***Display Sensor***
- ***Control Sensor***
- ***Scan Function***
- ***Filter Function***
- ***Control Parameters***
- ***Manual Control Settings***
- ***How to Manually Set PID Parameters***
- ***Sensor ID Switches***
- ***Sensor Curve Selection***

# OPERATING THE MODEL DRC-91CA TEMPERATURE CONTROLLER

## Power Up Sequence

Insert the power cord and press the power button on the front panel. The following will occur immediately upon powering on the temperature controller.

### Light Test

1. The Display Block indicates

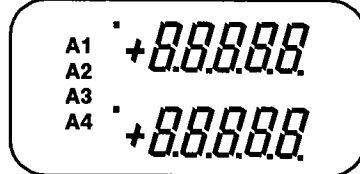

2. The Heater % reads



### Instrument Name and IEEE Address

1. Next the unit displays

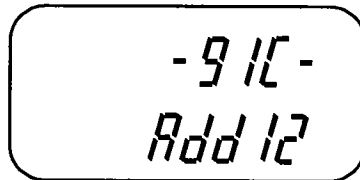

in the display block.

### NOTE

The factory sets the IEEE address at 12. This address can be changed by the user and verification of that change will always be given on Power Up.

### Sensor Input Card Configuration

1. The upper display will show the curve number and the lower display will show the input card type for channel A. (Refer to Table 3-1 for input card type information.)
2. Immediately following, the same information is displayed for channel B.

Table 3-1. Card Types and Corresponding Lower Display

Lower Display	Input Card	Configuration
10 - 3	9210	-3 silicon diode
10 - 6	9210	-6 GaAlAs diode
±15 - 15	9215	-15 capacitive
±15 - 50	9215	+15 capacitive
20 - 3	9220	-3 silicon diode
20 - 6	9220	-6 GaAlAs diode
20 - P2	9220	-P2 100Ω Pt.
20 - P3	9220	-P3 1000Ω Pt
20 - R1	9220	-R1 Rhodium Iron
±9305	9305 <sup>1</sup>	Thermocouple
±17C	9317C <sup>2</sup>	CGR or germanium
±18C	9318C <sup>2</sup>	CGR or germanium

1 - Compensation ON = +. Compensation OFF = -.

2 - Thermal Correction ON = +. Thermal Correction OFF = -.

# OPERATING THE MODEL DRC-91CA TEMPERATURE CONTROLLER

**NOTE** The sensor input card configuration can also be displayed by selecting the channel and then pressing the Local Key.

## Power Up Errors

On power up, if a problem occurs with memory,

*Err01* or *Err02*

will appear on the display.

If an unrecognized sensor input card is present, an

*Err25* or *Err26*

message may appear. This is normal if only one input card is present.

If a sensor signal outside the normal operating range is present at the input, an error message will appear. A signal of the wrong polarity is indicated by

*Err27* and/or *Err28*

An overload condition is indicated by

*OL*

If the sensor input is left unconnected, either message is possible. If an error is present at the control sensor, the heater will turn off. Note that any of the errors listed above could turn the heater off.

## Power Up Status Switch

A provision has been made to store parameter changes in the DRC-91CA's memory (NOVRAM). This ensures that it will power up into a user defined state after power down. Parameters such as the A and B display units, the control units, heater range, set point, and the scan dwell times are stored in non volatile memory and preserved even when the line cord is disconnected from the unit.

Switch 2 on S4 (See page 2-5 for location of S4 and proper procedure for removing the cover.) controls whether or not the NOVRAM is updated. When switch 2 is open, the feature is turned off and the unit will power up in the configuration it was last in when the power up feature was turned off. When switch 2 is closed, the feature is on and the power up settings will change when settings on the instrument are made via the front panel or over the remote interface. The updating is enabled (*switch 2 closed*) at the factory prior to shipment.

# OPERATING THE MODEL DRC-91CA TEMPERATURE CONTROLLER

## Display Sensor

Either Input A or Input B may be selected for the display sensor.

### Selecting Display Sensor Input Channel

To choose the display channel, simply press the A key or B key in the Display Sensor Block. The LEDs in the Display Sensor block to the left of the key will indicate which input is the display sensor. If there is an 8229 Scanner Option, pressing the A key repeatedly will scroll through the A inputs, A0 through A4 as indicated on the display.

### Selecting Display Sensor Units

The display units are located in the Display Sensor Block. To change the units for the display, press and hold the UNITS key and press the ▲▲ key to choose the units clockwise or the ▼▼ key to choose the units counterclockwise.

The units, which do not pertain to the input card selected, are automatically skipped (*i.e. only one of the sensor units (V,  $\Omega$ , or nF) is possible depending on which sensor input card is present within the instrument*). In the case of the 9215 card, temperature units are not allowed due to the inability of the sensor to hold a calibration upon cycling and therefore only displays in nanofarads.

## Display Resolution

### Temperature Resolution

The Model DRC-91CA allows you to set your display temperature resolution from 1 kelvin to 1 millikelvin. The temperature is rounded to the least significant digit of the resolution range selected.

#### NOTE

*This is display resolution and NOT system resolution or accuracy of the reading. Since the temperature display resolution is dependent on both the sensor temperature and the sensor sensitivity, actual temperature resolution is greatly dependent on the sensor type and temperature range.*

To examine the temperature resolution of the Display, press and hold the DISPLAY SENSOR channel A or B keys.

To change the resolution, press and hold the DISPLAY SENSOR A or B or key. Use the ▲▲ key or the ▼▼ key to move the decimal in the direction of increased or decreased resolution. When the desired resolution is reached, release both keys.

Changing the display resolution fixes the resolution transmitted over the computer interface as well, but does not change the resolution of the "system". Display resolution can also be different for each input card, i.e., A and B. Also note that the chosen resolution will only be displayed when "appropriate". When displaying in sensor units, resolution is fixed and remains unchanged by the resolution format.



# OPERATING THE MODEL DRC-91CA TEMPERATURE CONTROLLER

## **Voltage Resolution (V)**

The voltage mode is allowed for the 9210-3, 9210-6, 9220-3 and 9220-6 configurations. In voltage mode, the display has a resolution of 0.1 millivolt with the full range dependent on the input card (*2.9999 volts for the -3 configurations and the 8210 card and 6.5535 volts for the -6 configurations and the 8211 input card*). The actual Sensor Input Card resolution is 0.05 millivolts and 0.1 millivolts, respectively.

The 9305 card displays  $\pm 15\text{mV}$  with a resolution of 1 microvolt.

## **Resistance Resolution ( $\Omega$ )**

The Resistance mode is allowed for the 9317C, 9318C and the 9220-P2, -P3, and -R1 configurations. It is also available for the DRC-81C/82C series 8219-P2, -P3 and -R1 cards.

## **Capacitance Resolution**

The capacitance mode is allowed for the 9215 input card which can be in a -15 or -150 configuration. The display range and resolution is 0.000 to 30.000 or 0.00 to 150.00 nanofarads, respectively. An input in excess of the configured maximum is indicated by OL on the display.

## **Control Sensor**

Either Input A or Input B may be used as the control sensor.

### **NOTE**

*We do not recommend using Input A as the control sensor when the 8229 Scanner Option is in place or all 5 sensors will be used as control sensors while scanning.*

## **Selecting Control Sensor Input Channel**

To select the control channel, toggle the Control Sensor Switch on the rear panel to either A or B. The LEDs in the Control Sensor Block will indicate which channel is the control sensor.

## **Selecting Control Sensor Units**

The control units are located below the Control Sensor Block and are the units for the set point. To change the units for the control sensor, press and hold the UNITS key and press the  $\blacktriangle$  key to choose the units clockwise or the  $\blacktriangledown$  key to choose the units counterclockwise.

The units, which do not pertain to the input card selected, are automatically skipped (*i.e. only one of the sensor units (V,  $\Omega$ , or nF) is possible depending on which sensor input card is present within the instrument*). In the case of the 9215 card, temperature units are not allowed due to the inability of the sensor to hold a calibration upon cycling and therefore only displays in nanofarads.

## **Display Resolution**

The control resolution is the same as the display resolution and can not be set independently.

# OPERATING THE MODEL DRC-91CA TEMPERATURE CONTROLLER

---

## **The SCAN Function**

The SCAN function allows the instrument to step between the inputs with a scan rate independently set between 0 (Skip) and 99 seconds for each input. Setting a dwell time to zero, automatically skips the channel **only** when in the SCAN mode. If the scanner option is present, inputs (A1-A4) are included in the SCAN function and each has its own dwell time which is set independently.

## **The SCAN Dwell Time**

To display the dwell time for the channel chosen as display, press the  key and hold for approximately three seconds.

To change the dwell time, press the ▲ key or the ▼ key to increment or decrement the display dwell time for the input chosen.

A similar result can be obtained by pressing and holding the A or B Input keys and using the ▲ key and the ▼ key as before. When using this procedure, the display will show the resolution and the dwell time.

A dwell time of less than 5 seconds is not recommended.

## **Filter Function**

An averaging routine within the instrument is available which averages ten readings. This reading mode eliminates noise within the cryogenic system analogous to averaging within a digital voltmeter.

The filter can be turned on or off with Switch 2 of the SENSOR IDs on the rear panel. When the switch is closed, the filter is on. This is shown by a filter indicator in the upper left hand corner of the display.

The DRC-91CA is shipped from the factory with the filtering function off for both inputs.

# OPERATING THE MODEL DRC-91CA TEMPERATURE CONTROLLER

## Control Parameters

Refer to The Fundamentals For Usage Of Cryogenic Temperature Controllers as an application note in the appendices of this manual for further description of control parameters.

### Setpoint

The setpoint is the temperature or sensor value you want the DRC-91CA to control to. To change the setpoint:

1. Press the ▲ key or the ▼ key to increment or decrement the least significant digit.
2. Press the ▲▲ key or the ▼▼ key to change the third digit from the right.
3. Press the ▲▲ key and the ▲ key or the ▼▼ key and the ▼ key at the same time to change the fourth digit from the right.

If one of these combinations is held down for longer than 2 seconds, the rate at which the setpoint changes is increased by a factor of five. If the units are Celsius, Fahrenheit or millivolts the (+/-) key can be used to toggle the sign of the setpoint.

#### NOTE

*The setpoint resolution is limited to 0.1K, C or F. It is sometimes possible to increase the setpoint resolution by setting the setpoint in sensor units (V, mV, Ω).*

### Gain

The variable gain allows adjustment of overall controller gain over a range from 1 to 1000. To set the gain, use the Gain knob. Maximum gain is full clockwise. Logarithmic scaling is used; therefore, a gain setting of x100 is approximately two-thirds of full rotation.

### Rate

This adjusts the rate time constant of differentiator in the control function. Effective settings are between 0.1 second and 99 seconds, with the full clockwise rotation (99) representing the longest time constant.

### Reset

Adjusts the reset time constant of integrator in the control function. Effective reset time constants, between 990 seconds and 1 second, can be achieved by entering reset settings of 0.1 to 99. Reset time in seconds is  $(990/(10 \times \text{Value Entered}))$ . The higher the value entered, the faster the integration time of the reset function. A reset of zero will turn off the reset.

For example, if the reset setting is 20, the reset time in seconds is approximately five  $(990/10 \times 20 = 5)$ .

### Heater Range

The heater power range setting is determined by the keys directly below the Heater Power display on the front panel. MAX = full scale. Each consecutive key is a ten times reduction in power. -1, -2 and -3 correspond to a  $10^{-1}$ ,  $10^{-2}$ , and  $10^{-3}$  multiplier, respectively. The OFF key turns off the output power independent of the setpoint and the control parameters. (See Section 2 for more information on heater power.)

On a range change, the DRC-91CA ramps the gain to 0 and turns OFF the reset and rate prior to changing ranges. After the range is changed, the settings are returned to what they were prior to the range change. This protects the load from seeing the increase or decrease in range power as a step function.

# **OPERATING THE MODEL DRC-91CA TEMPERATURE CONTROLLER**

---

## **How to Manually Set PID Parameters**

### ***How do I determine an appropriate gain setting for my cryogenic system?***

First, turn off both RESET and RATE. Set in a nominal gain setting of 50. Make sure that the heater turns on; if not, increase the gain setting until it does. Let the system stabilize. Note that it will stabilize at some point below the set point. Keep increasing the controller gain by factors of two until the system temperature begins to oscillate. Adjust the gain for small sustained oscillations. Measure the period of these oscillations for determining the correct setting for reset. Reduce the gain by a factor of two to three until the temperature again becomes stable with time. Be sure that you allow time at each setting for the system to stabilize if it will. For some systems and cryogenic sensors with low sensitivity, the maximum controller gain may not cause the system to oscillate, even at maximum gain settings.

### ***When I enter a reset number, how does that relate to my cryogenic system?***

The reset number is an industrial control term which in the DRC-91CA corresponds to the number of repeats (or time constants) per 1000 seconds. The time constant is 1000 divided by this number in seconds. Consequently, a reset number setting of 20 corresponds to a time constant of 50 seconds. A system will normally take several time constants to settle into the set point, e.g. the 50 second time constant, if correct for the system being controlled, would result in a stable set point in a time frame between 5 and 10 minutes.

### ***How do I determine RESET?***

The oscillation period which you measured in determining the appropriate gain setting is equal to the reset time constant which is desired. Divide this number in seconds into 1000 and set the result into the RESET register. This result is the number of repeats per 1000 seconds. If the system did not oscillate at the highest gain setting, use the following procedure. Stabilize the temperature at a high gain setting. Change the set point downward by one or two degrees and observe the time that it takes for the temperature to change 60% of this excursion. Use this number as the reset time constant; divide it into 1000 and set in the result as the RESET value.

### ***What about RATE?***

The rate time constant should normally be somewhere between 1/4 and 1/8 the reset time constant in seconds if it is used at all. Don't be surprised if for your system, the setting you prefer is 0 (OFF).

### ***How does reset change with temperature?***

In a normal cryogenic system, the time response of the system slows down as the temperature increases. Consequently, as the temperature rises, the time constant will become longer as well. Therefore, if you have determined a valid value of reset at a particular temperature, increasing the temperature will result in a decrease in the reset number, i.e., a longer time constant; conversely decreasing temperature will demand a shorter time constant, i.e., an increase in the reset setting.

### ***For a silicon diode sensor, why does the optimum controller gain value increase by nearly an order of magnitude between 25K and 35K?***

The system gain is a product of the controller gain and the sensor gain, i.e., sensor sensitivity. At 25K, the sensor sensitivity (dV/dT) is approximately an order of magnitude larger than it is at 35K. If the load parameters have not changed greatly, neither will the system gain. Therefore, the controller gain must be increased to compensate for the reduction in sensor sensitivity.

### ***What happens to the system gain as the temperature increases?***

It normally increases. Consequently, if the sensor sensitivity is relatively constant, you can normally increase the controller gain with increasing temperature.

# OPERATING THE MODEL DRC-91CA TEMPERATURE CONTROLLER

## Sensor ID Switches

The A Sensor ID and B Sensor ID Switches on the rear panel.

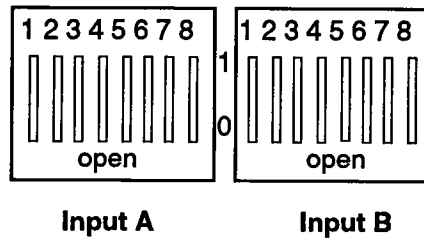

Their functions are to;

- Select curve number
- Select curve position if more than 1 curve is used for an input
- Activate or deactivate digital filtering (see page 3-6);
- Determine slope for a 9215 capacitance sensor input card if present;
- Enable thermal averaging on the 9317C or 9318C resistance sensor input card when present.
- Enables ice-point compensation when a 9305 thermocouple input card is present;

The table below gives a description of which switches activate the items listed above. Functions for switches 1, 2, and 3 are very self explanatory. Further explanation, if needed, can be found in the Input/Option card section.

The following pages will give detailed explanation for the operation of switches 4 through 8 as they pertain to curve and position selection.

Switch	Setting	Description	Option Card
1	Open	Negative Slope	(9215)
	Closed	Positive Slope	(9215)
2	Open	Continuous Update	
	Closed	Digital Filter On	
3	Open	No Thermal Considered or Temperature Compensation Off	(9317C/9318C) (9305)
	Closed	Thermal Considered or Temperature Compensation On	(9317C/9318C) (9305)
4	Open	Curve Selection	
	Closed	Position Selection	
5		Curve or Position Bit 3	
6		Curve or Position Bit 2	
7		Curve or Position Bit 1	
8		Curve or Position Bit 0	

# OPERATING THE MODEL DRC-91CA TEMPERATURE CONTROLLER

## Sensor Curve Selection

This section should be read carefully to fully understand how sensor curves and remote positions are selected in this instrument and how they are used with internal and external scanners. Discussion will center around

- normal operation with curves 00 through 15
- operation with curve numbers above 15
- operation with the internal 8229 Scanner Option
- operation with external scanners

The Sensor Curve Table on the following page gives standard curves present in the temperature controller as well as any Precision Options which are factory installed (*including the number of data points for each curve*). The table should be updated as additional curves are added.

A Precision Option Curve can have up to 97 points with two additional end points automatically put into the curve table by the DRC-91CA software. Up to 20 Precision Option Curves can be stored in the DRC-91CA with an average of 31 points per curve.

## Normal Curve Selection With Curves Numbered 00 Through 15

When switch 4 is open (0) on either of the A or B SENSOR ID switches on the rear panel, switches 5-8 will select a curve 00 through 15. Refer to the Sensor Curve Table on the following page for the appropriate dip switch settings for each curve.

### Display of Curves

To determine which curve you are using, select either A or B Input. Next, press and hold the LOCAL key. After 2 seconds, the curve will be displayed. An example;

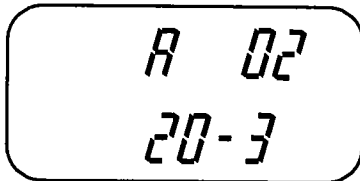

The top line indicates the channel and curve while the lower line indicates the input card. See Page 3-2 for other possible input card indications.

The above example indicates that a 9220 Sensor Input Card in the -3 configuration is present in Input A and that the instrument is using Curve #2 for that input.

Since the DRC-91CA knows which type of sensor input card is present, it will not, for example, allow the use of the platinum curve (Curve #3) for a diode sensor input card. If Curve #3 is selected from the back panel SENSOR ID Switch, the DRC-91CA will default to the lowest curve number with the correct temperature coefficient. In this case, Curve #00.

# OPERATING THE MODEL DRC-91CA TEMPERATURE CONTROLLER

**Sensor Curve Table**

Curve #	Switch Settings*	# Of Lines	Temp. Range.	Description	<i>with 9305 card</i>
00	00000	31	1-324.9	DRC-D	<i>Au0.07%Fe</i>
01	00001	31	1-324.9	DRC-E1	<i>Au0.03%Fe</i>
02	00010	31	1-324.9	CRV 10	<i>E</i>
03	00011	31	14-799.9	DIN-PT	<i>K</i>
04	00100	31	1-474.9	CRV 10	<i>T</i>
05	00101	31		RESVRD	<i>RESVRD</i>
06	00110	---	---	---	---
07	00111	---	---	---	---
08	01000	---	---	---	---
09	01001	---	---	---	---
10	01010	---	---	---	---
11	01011	---	---	---	---
12	01100	---	---	---	---
13	01101	---	---	---	---
14	01110	---	---	---	---
15	01111	---	---	---	---
16		---	---	---	---
17		---	---	---	---
18		---	---	---	---
19		---	---	---	---
20		---	---	---	---
21		---	---	---	---
22		---	---	---	---
23		---	---	---	---
24		---	---	---	---
25		---	---	---	---
26		---	---	---	---
27		---	---	---	---
28		---	---	---	---
29		---	---	---	---
30		---	---	---	---
31		RESERVED		(ERR 09)	

\*Dip Switch Settings for Sensor ID switches 4,5,6,7 and 8. 0 is open and 1 is closed.  
 Note that switch 4 is open (0).

The table above gives the curve number for the standard curves and should be updated when any precision options are added.

# OPERATING THE MODEL DRC-91CA TEMPERATURE CONTROLLER

## Operation With Curve Numbers Higher Than 15

To allow scanners (8229 and the 8085) to be used with precision options and have the DRC-91CA automatically select the correct curve, Lake Shore has added the **Position # Versus Curve # Table**. When switch 4 is closed (1) on either of the SENSOR ID switches on the rear panel, switches 5-8 will select position number and NOT curve number. When operating with curves higher than 15, this feature allows the user to assign these curves to the instrument. That is, if the user has a curve # higher than 15, he can assign its curve # to a position [00-15] in the table and select that position.

**Position # Versus Curve # Table**

Position #	Switch Settings*	Remote Sensor ID Settings**	Internal Correlation Table	
			INPUT A	INPUT B
00	10000		A00 _____	B00 _____
01	10001	00001	A01 _____	B01 _____
02	10010	00010	A02 _____	B02 _____
03	10011	00011	A03 _____	B03 _____
04	10100	00100	A04 _____	B04 _____
05	10101	00101	A05 _____	B05 _____
06	10110	00110	A06 _____	B06 _____
07	10111	00111	A07 _____	B07 _____
08	11000	01000	A08 _____	B08 _____
09	11001	01001	A09 _____	B09 _____
10	11010	01010	A0A _____	B0A _____
11	11011	01011	A0B _____	B0B _____
12	11100	01100	A0C _____	B0C _____
13	11101	01101	A0D _____	B0D _____
14	11110	01110	A0E _____	B0E _____
15	11111	01111	A0F _____	B0F _____
16		10000	A10 _____	B10 _____
17		10001	A11 _____	B11 _____
18		10010	A12 _____	B12 _____
19		10011	A13 _____	B13 _____
20		10100	A14 _____	B14 _____
21		10101	A15 _____	B15 _____
22		10110	A16 _____	B16 _____
23		10111	A17 _____	B17 _____
24		11000	A18 _____	B18 _____
25		11001	A19 _____	B19 _____
26		11010	A1A _____	B1A _____
27		11011	A1B _____	B1B _____
28		11100	A1C _____	B1C _____
29		11101	A1D _____	B1D _____
30		11110	A1E _____	B1E _____
31		11111	A1F ERR09	B1F ERR09

Note that the **Position # Versus Curve # Table** now has *Position* in the first column. This is in contrast to the **Sensor Curve Table** which has *Curve* in the first column.

\*Dip Switches 4,5,6,7 and 8 of Sensor ID Switch. 0=open and 1-closed.

Note that switch 4 is closed (1).

\*\*REMOTE SENSOR ID Bits 4-0 for use with external scanners.

The DRC-91CA is shipped from the factory with curve 02 stored in all positions of this table.



# OPERATING THE MODEL DRC-91CA TEMPERATURE CONTROLLER

## Display of Curves In Position Mode

Press and hold the LOCAL key for more than 1 second. The Display and Heater % windows will have the following format:

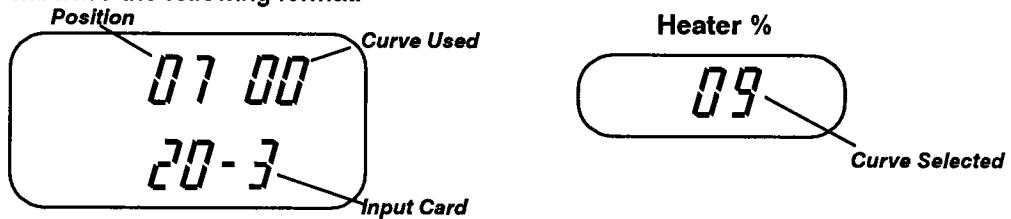

Since the Heater % display is not blank, we know that the SENSOR ID switches are indicating position and **not** curve number. The larger display will show the same curve number as displayed in the Heater % display if that curve is valid.

For the example above, switches 45678 are set as 10111 selecting position 7. The curve selected is Curve #09. The Heater % display does not match the larger display. Either that curve does not exist or it is not a diode curve since the instrument is defaulting to the lowest number diode curve, 00 (*shown in the larger display*).

## To Change The Curve Number For A Certain Position

Press the LOCAL key until the curve and position are displayed as shown above. Use the ▲ and ▼ keys to change the curve number in the Heater % display for the position indicated in the larger display. If a valid curve for the position indicated is selected, the curve number will also display in the upper right hand corner of the larger display. If the same curve does not show in the larger display window as in the Heater % display, than the curve chosen is not valid.

## Sensor Curve Assignment With 8229 Scanner Option

Adding the 8229 Scanner Option to Input A with Switch 4 closed (1) overrides switches 5-8 of the A SENSOR ID as described on page 3-12. Scanner inputs A0 through A4 now correspond to positions A00 through A04 (*indicated in bold letters in the Position # Versus Curve # Table on page 3-12*). Consequently, different curves can be assigned to each of the five positions corresponding to each of the five scanner inputs.

## Display of Curves With Switch 4 Of The Sensor ID Switch Closed (1)

Use the A channel key to select the channel you wish to have displayed (A0-A4). Press and hold the LOCAL key for more than 1 second. The curve will be displayed in the upper right corner of the display window and in the Heater % display (*see drawing above*).

## To Change The Curve Number

Press the LOCAL key until the curve and position are displayed as shown above. Use the ▲ and ▼ keys to change the curve number in the Heater % display for the position indicated in the larger display. If a valid curve for the position indicated is selected, the curve number will also display in the upper right hand corner of the larger display. If the same curve does not show in the larger display window as in the Heater % display, than the curve chosen is not valid.

# OPERATING THE MODEL DRC-91CA TEMPERATURE CONTROLLER

## Sensor Curve Assignment With External Scanners

Lake Shore sells the Model 8085 Scanner which can be used with the DRC-91CA. Up to three 8085 Scanners can be daisy-chained together to give up to 30 sensor inputs for either the A input or the B input of the DRC-91CA. Curve selection is handled differently when these scanners are used.

## REMOTE SENSOR ID And The Position # Versus Curve # Table

The REMOTE SENSOR ID (J5) connector located on the rear panel, along with the J1 or J2 input, are used to connect external scanners to the DRC-91CA. If the unit senses that the REMOTE SENSOR ID has an external scanner plugged into it, then the Position # Versus Curve # Table is valid for positions 01 through 30. The Sensor ID switches 5-8 are now ignored. Remember that switch 4 on one Sensor ID switch located on the rear of the DRC-91CA must still be closed (1).

**CAUTION** Do not set both SENSOR ID switch 4s to 1 since only one input should be tied to the REMOTE SENSOR ID and its position.

Refer to the Position # Versus Curve # Table on page 3-12 and note that column 3 is the bit settings on the external scanner. The differences from the SENSOR ID's is that the position can be changed remotely and 30 positions rather than 16 are available for one (*but not both*) of the inputs.

### REMOTE SENSOR ID Connector Pin Assignments

15	13	11	9	7	5	3	1
16	14	12	10	8	6	4	2
ONLY BOLD PINS USED							
J5	Function						
1	+5						
2	Reserved						
4	Bit 3						
6	Bit 2						
8	Bit 1						
10	Bit 0 (LSB)						
12	Digital Ground						
14	Bit 4 (MSB)						
16	Reserved						

## Display of Curves with External Scanners

Press and hold the LOCAL key for more than 1 second. The curve will be displayed in the upper right corner of the display window and in the Heater % display (*see drawing on page 3-13*).

## To Change The Curve Number

Press the LOCAL key until the curve and position are displayed as shown above. Use the ▲ and ▼ keys to change the curve number in the Heater % display for the position indicated in the larger display. If a valid curve for the position indicated is selected, the curve number will also display in the upper right hand corner of the larger display. If the same curve does not show in the larger display window as in the Heater % display, then the curve chosen is not valid.

# REMOTE OPERATION OF THE MODEL DRC-91CA TEMPERATURE CONTROLLER

# 4

This section shows you the fundamentals of operating the Model DRC-91CA Controller from remote. It includes a description of:

- IEEE-488 Interface
- General IEEE Specifications
- Interface Capabilities
- IEEE-488 Address Switch
- IEEE-488 Commands
- Serial Interface
- Interface Commands
- Thermometry Commands
- Scan Commands
- Control Commands
- Status Registers
- Curve Commands
- Sample Programs
- Sensor Units Format For Curve Storage

Function	Command	Page	Function	Command	Page
<b>INTERFACE</b>			<b>CONTROL</b>		
Mode	M	4-10	Setpoint	S	4-21
EOI Status	Z	4-10	Gain	P	4-22
Terminating Character	T	4-11	Rate	D	4-22
Turn On State	C	4-11	Reset	I	4-23
Interface Setup Query	W2	4-12	Heater Range	R	4-23
<b>THERMOMETRY</b>			Control Query	W3	4-24
Control Sensor Units	F0	4-13	Setpoint Query	WP	4-24
Display Units	F1A&F1B	4-13	<b>SERVICE REQUEST</b>		
Display Sensor	F2A&F2B	4-14	Service Request	Q	4-27
Temperature Resolution	F3A&F3B	4-14	Service Request Query	WQ	4-28
Sensor ID Switch	A&B	4-15	<b>CURVE</b>		
A&B Input Query	W1	4-16	Curve Entry	XC*	4-29
Sample Sensor Query	WS	4-17	Curve Edit	XE*	4-30
Display Sensor Query	WC	4-17	Curve Erase	XK*	4-30
Display Data Query	W0	4-17	Curve Remote Position	XA*&XB*	4-31
<b>SCAN</b>			Internal Curve Erase	XR&I*	4-31
Scan	YS	4-18	Curve Query	XD	4-32
Scan Stop	YH	4-18	Curve Table Query	XDT	4-33
Scan Dwell	YA&YB0	4-19	All Curve Query	XDA	4-33
Scan Channels	YCA	4-19			
Scan Status Query	WY	4-20			

## REMOTE OPERATION OF THE MODEL DRC-91CA

---

### **IEEE-488 Interface**

The IEEE-488 INTERFACE is an instrumentation bus with hardware and programming standards designed to simplify instrument interfacing. The IEEE-488 INTERFACE of the DRC-91CA fully complies with the IEEE-488-1978 standard and incorporates the functional, electrical and mechanical specifications of the standard. It also follows the supplement to the standard titled "Code and Format Conventions for use with IEEE Standard 488-1978".

### **General IEEE Specifications**

All instruments on the interface bus must be able to perform one or more of the interface functions of TALKER, LISTENER, or BUS CONTROLLER. A TALKER transmits data onto the bus to other devices. A LISTENER receives data from other devices through the bus. The BUS CONTROLLER designates to the devices on the bus which function to perform.

The DRC-91CA performs the functions of TALKER and LISTENER but cannot be a BUS CONTROLLER. The BUS CONTROLLER is your digital computer which tells the DRC-91CA which functions to perform.

### **Interface Capabilities**

The IEEE-488 interface capabilities of the Model DRC-91CA Temperature Controller are listed below as well as in mnemonic format on the instrument's rear panel.

SH1	source handshake capability
AH1	acceptor handshake capability
T5	basic TALKER, serial poll capability, talk only, unaddressed to talk if addressed to listen
L4	basic LISTENER, unaddressed to listen if addressed to talk
SR1	service request capability
RL1	complete remote/local capability
PP0	no parallel poll capability
DC1	full device clear capability
DT0	no device trigger capability
C0	no system controller capability
E1	open collector electronics

# REMOTE OPERATION OF THE MODEL DRC-91CA

## DRC-91CA IEEE-488 ADDRESS SWITCH

The IEEE-488 Address Switch is located on the instrument's rear panel. It serves three basic functions;

- Sets Terminating Characters
- Determines Talker/Listener Status
- Sets the IEEE Address

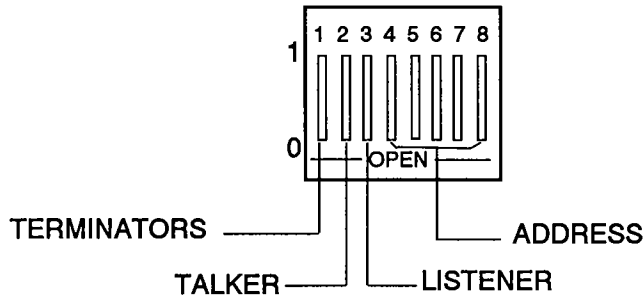

For the default of 12, address switch numbers 5 and 6 will be CLOSED (1) which will result in the Address Switch having a setting of 00001100 or 10001100 dependent on the requirements for the terminators.

### Terminating Characters

Switch 1 (\*) is used to define the instrument's terminating characters. The OPEN (0) position selects the ASCII characters Carriage Return (CR) and Line Feed (LF) as the terminating characters for input and output. When the DRC-91CA is putting out data, the End or Identify (EOI) line is set with the output of the LF character.

When Switch 1 (\*) is CLOSED (1), a variable terminating character format may be selected for the input and output data. In this configuration, the power-up terminating characters are LF and CR with the EOI line being set with the output of the CR. With the (\*) switch closed the terminating characters can be changed via the remote interface. If the terminating characters are changed by the user, these are only in effect until the instrument is turned off.

### TALKER and/or LISTENER Configuration

Since the DRC-91CA is both a TALKER and a LISTENER, normally switches two and three should both be OPEN (0). These switches are of use when one instrument is a TALKER and another instrument is a LISTENER and they are to share the same address.

Function	Bit	
	2	3
Talk only	1	0
Listen only	0	1
Talk/Listen	0	0
Invalid	1	1

## REMOTE OPERATION OF THE MODEL DRC-91CA

---

### Setting the DRC-91CA IEEE Address Switch

The factory preset address of this instrument is 12. The bus address for the DRC-91CA is set by switches 4 through 8, which are reserved for the address selection. Switch 4 is the most significant bit (MSB bit weighting [=16]) and switch 8 is the least significant bit (LSB bit weighting [=1]).

To set the IEEE Address;

1. The instrument should be off since the DRC-91CA updates the IEEE address only on power-up.
2. Set the switches to the desired address. (*Refer to the table on page 4-5 for the proper settings.*)
3. Make sure Switch 1 is OPEN (0) to select (CR)(LF) as the terminating characters or CLOSED (1) to select the terminating characters over the interface.
4. If the TALKER or LISTENER status needs to be changed, see discussion on page 4-3.
5. Turn on the DRC-91CA and confirm that the address selected is correct by holding in the REMOTE key on the front panel for longer than one second. An example of what you might expect to see;

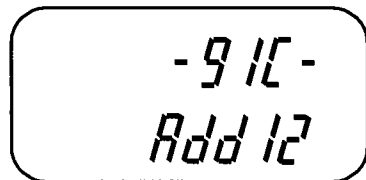

# REMOTE OPERATION OF THE MODEL DRC-91CA

## Allowable Address Codes

ASCII Code Character		Address Switches					5-bit Decimal Code
Listen	Talk	4	5	6	7	8	
		B5	B4	B3	B2	B1	
!	A	0	0	0	0	1	01
"	B	0	0	0	1	0	02
#	C	0	0	0	1	1	03
\$	D	0	0	1	0	0	04
%	E	0	0	1	0	1	05
&	F	0	0	1	1	0	06
'	G	0	0	1	1	1	07
(	H	0	1	0	0	0	08
)	I	0	1	0	0	1	09
*	J	0	1	0	1	0	10
+	K	0	1	0	1	1	11
,	L	0	1	1	0	0	12
-	M	0	1	1	0	1	13
.	N	0	1	1	1	0	14
/	O	0	1	1	1	1	15
0	P	1	0	0	0	0	16
1	Q	1	0	0	0	1	17
2	R	1	0	0	1	0	18
3	S	1	0	0	1	1	19
4	T	1	0	1	0	0	20
5	U	1	0	1	0	1	21
6	V	1	0	1	1	0	22
7	W	1	0	1	1	1	23
8	X	1	1	0	0	0	24
9	Y	1	1	0	0	1	25
:	Z	1	1	0	1	0	26
;	[	1	1	0	1	1	27
<	\	1	1	1	0	0	28
=	]	1	1	1	0	1	29
>	~	1	1	1	1	0	30



## IEEE-488 Commands

The DRC-91CA supports several command types. These commands are broken into three groups;

1. Bus Control
  - Universal
    - Uniline
    - Multiline
  - Addressed Bus Control
  - Unaddress Bus Control
2. Device Specific

### Bus Control Commands

#### *The Universal Commands*

A Universal Command is a command that addresses all devices on the bus. Universal Commands include Uniline and Multiline Commands.

A **Uniline Command** (Message) is a command which results in a single signal line being asserted. The DRC-91CA recognizes two of these messages from the BUS CONTROLLER; **Remote (REN)** and **Interface Clear (IFC)**. The DRC-91CA will send one Uniline Command (**SRQ**).

**REN (Remote)** - Puts the controller into a remote mode.

**IFC (Interface Clear)** - Stops current operation on the bus.

**SRQ (Service Request)** - Tells the bus controller that the DRC-91CA needs interface service.

A **Multiline Command** involves a group of signal lines. All devices equipped to implement such commands will do so simultaneously when the command is transmitted. These commands are transmitted with the Attention (ATN) line asserted low. There are two Multiline commands recognized by the DRC-91CA.

**LLO (Local Lockout)** - LLO is sent to instruments to lock out (i.e., prevent the use of) their front panel controls.

**DCL (Device Clear)** - DCL is used to clear the DRC-91CA's interface activity and put it into a bus idle state.



## **REMOTE OPERATION OF THE MODEL DRC-91CA**

---

### *The Addressed Bus Control Commands*

The Addressed Bus Control Commands are Multiline commands that must include the DRC-91CA listen address before it will respond to the command in question. Note that only the addressed device will respond to these commands. The controller recognizes three of the Addressed Bus Control Commands.

**SDC (Selective Device Clear)** - The SDC command performs essentially the same function as the DCL command except that only the addressed device responds.

**GTL (Go To Local)** - The GTL command is used to remove instruments from the remote mode. With some instruments, GTL also unlocks front panel controls if they were previously locked out with the LLO command.

**SPE (Serial Poll Enable) and SPD (Serial Poll Disable)** - Serial polling is used to obtain the Service Request (SRQ) Status Register. This status register contains important operational information from the unit requesting service. The SPD command ends the polling sequence.

### *The Unaddressed Bus Control Commands*

The Unaddressed Commands are used by the BUS CONTROLLER to remove any TALKERS or LISTENERS from the bus. The ATN line is asserted low when these commands are transmitted.

**UNL (Unlisten)** - LISTENERS are placed in the listener idle state by the UNL command.

**UNT (Untalk)** - Previous TALKERS will be placed in the TALKER idle state by the UNT command.

# REMOTE OPERATION OF THE MODEL DRC-91CA

## Device Specific Commands

Device Specific Commands are addressed commands. The DRC-91CA supports a variety of Device Specific commands to allow the user to program the instrument remotely from a digital computer and to transfer measurements to the computer. The commands are broken down into Interface, Thermometry, Scan, Control and Curve commands for user convenience. There are individual discussions on each command and they are handled in the format described below.

Command Name \_\_\_\_\_

Brief Description of Function \_\_\_\_\_

Syntax of what user must input. For commands, any additional information needed on input will be described in parameters. All parameters are enclosed in brackets. For queries, an explanation will be given of what the user can expect to have returned.

The remarks section will only be used if any additional features about the command need to be discussed.

The example section will only be used if an example is required.

<b>WI</b>	
<b>Description</b>	This query returns the input cards present in Inputs A and B and the options.
<b>Syntax</b>	
<b>Input</b>	WI
<b>Returned</b>	38 characters plus terminators [A-A Input Card (7 characters)], [B-B Input Card (7 characters)], [1-Option 1 present (4 characters)], [2-Option 2 present (4 characters)], [3-Option 3 present (4 characters)]
<b>Remarks</b>	
<b>Example</b>	A typical data string would be: A-9220-P2, B-9318C, 1-8225, 2-8223, 3-8229  which indicates a 9220 card configured as a 100 ohm platinum input for Input A; a germanium/carbon glass input for Input B; a linear analog option in Option Slot 1; an RS-232C option in Option Slot 2 and a Scanner Card option in Option Slot 3.

## REMOTE OPERATION OF THE MODEL DRC-91CA

### **Additional Notes On Commands**

When the term **free field** is used, it indicates that the decimal point is a floating entity and can be placed any appropriate place in the string of digits.

**[term]** is used when examples are given and indicates where terminating characters should be placed by the user or where they appear on a returning character string from the unit.

Commands may be chained together. Multiple queries cannot be chained. The unit will respond to the last query entered when addressed as a talker.

Queries generally have a W in front and cover a group of commands. There are some queries that have no command form.

Leading zeros and zeros following a decimal point are not needed in a command string, but they will be sent in response to a query.

The DRC-91CA must be addressed as a "LISTENER" to receive any instruction or string of instructions from the command list.

The DRC-91CA input data format does not require a set number or set sequence of commands to implement proper instrument set-up. These commands are processed only after the terminators are sent across the bus.

The Output Statement Requests are sent by the BUS CONTROLLER to the DRC-91CA to tell the DRC-91CA what data to output when data output is requested.

#### **Caution**

**Changes in the Gain, Rate, Reset and Sensor ID switch A and Sensor ID switch B in the IEEE Interface, will clear and return to the Local front and rear panel set up when the DRC-91CA is returned to local operation.**

### **Serial Interface**

The optional Serial Interface allows the temperature controller to communicate with instruments having an RS-232C interface. Communication parameters are discussed in the 8223 Option Card section. The Serial Interface shares Device Specific commands with the IEEE-488 interface. However, without the advantage of the IEEE-488 Architecture, there are several limitations:

- None of the Bus Control Commands apply.
- Serial Poll feature is not supplied
- A query must be added to the end of a command string if the DRC-91CA is required to return information. (*Over IEEE-488, the last query response is sent when addressed to talk.*)

## REMOTE OPERATION OF THE MODEL DRC-91CA

---

### Interface Commands

These commands help configure the IEEE-488 Interface so that it is compatible with the variety of computer equipment being used as controllers.

---

## M

---

**Description** Sets the DRC-91CA to local mode, remote mode or remote mode with local lockout.

**Syntax**

**Input** M[mode]

**[mode]** Fill in the mode parameter with 0 for local mode, 1 for remote mode, or 2 for remote mode with local lockout.

**Remarks** The DRC-91CA can also be put in remote by pressing the REMOTE key on the front panel.

Many PC compatible IEEE-488 cards automatically place addressed instruments into Local Lockout. To be able to place the temperature controller into remote without local lockout, you may need to reconfigure your IEEE-488 card.

---

## Z

---

**Description** Selects the End or Identify (EOI) status.

**Syntax**

**Input** Z[EOI status]

**[EOI status]** Fill in the EOI status parameter with 0 to enable the EOI and 1 to disable it.

**Remarks** When EOI is enabled, the hardware EOI line becomes active with the last byte of a transfer. Use of EOI identifies the last byte allowing for variable length data transmissions.

---

# T

---

**Description** Determines terminating character type.

**Syntax**

**Input** T[type]

**[type]** The following are choices for the type parameter.

- 0 for a carriage return and line feed (CR)(LF<sup>EOI</sup>)
- 1 for a line feed and carriage return (LF)(CR<sup>EOI</sup>)
- 2 for a line feed (LF<sup>EOI</sup>)
- 3 for no terminating characters (DAB<sup>EOI</sup>). *DAB = Last Data Byte.*

**Remarks** Switch 1 of the IEEE address switch defines the terminator status. If switch 1 is OPEN (0), the terminator status can not be changed over the interface and is always (CR)(LF<sup>EOI</sup>). When switch 1 is CLOSED (1) the terminator status can be changed using the T command.

---

---

# C

---

**Description** Sets the controller to the turn-on state.

**Syntax**

**Input** C

**Remarks** This action is similar to turning the instrument off and then back on, except that it occurs in milliseconds rather than seconds. The DRC-91CA does not go through the power-up display sequence.

---

---

## Interface Queries

---

# W2

---

**Description** This query returns interface setup information to the user.

**Syntax**

**Input** W2

**Returned** Z[EOI status],M[mode],T[type]

*Refer to the Z, M and T commands for parameter definitions.*

---

# WI

---

**Description** This query returns the input cards present in Inputs A and B and the options.

**Syntax**

**Input** WI

**Returned** 38 characters plus terminators

[A-A Input Card (7 characters)],[B-B Input Card (7 characters)],[1-Option 1 present (4 characters)],[2-Option 2 present (4 characters)],[3-Option 3 present (4 characters)]

**Example** A typical data string would be:

**A-9220-P2, B-9318C, 1-8225, 2-8223, 3-8229[term]**

which indicates a 9220 card configured as a 100 ohm platinum input for Input A; a germanium/carbon glass input for Input B; a linear analog option in Option Slot 1; an RS-232C option in Option Slot 2 and a Scanner Card option in Option Slot 3.

---

## Thermometry Commands

These commands configure the display.

---

# F0

---

**Description** Sets the control sensor units for the setpoint.

### Syntax

**Input** F0[units]

**[units]** Fill in the units parameter with **K** for kelvin; **C** for celsius; **F** for Fahrenheit **S** for volts, ohms or nanofarads.

**Remarks** Sensor units are selected automatically for the sensor unit input card type when **S** is used.

---

# F1A & F1B

---

**Description** Selects the A or B Display units.

### Syntax

**Input** F1A[units] or F1B[units]

**[units]** Fill in the units parameter with **K** for kelvin; **C** for celsius; **F** for Fahrenheit **S** for volts, ohms or nanofarads.

---

## F2A & F2B

---

**Description**      Selects the Display Sensor

**Syntax**

**Input**    F2A[channel] or F2B[channel]

**[channel]**    Fill in the channel parameter with

0 for	A or B
1 for	A1
2 for	A2
3 for	A3
4 for	A4

**Remarks**      A1 through A4 are only available if there is an 8229 Scanner Option.

---

## F3A & F3B

---

**Description**      Selects the A or B Input temperature resolution.

**Syntax**

**Input**    F3A[resolution] or F3B[resolution]

**[resolution]**    Fill in the resolution parameter with

0 for	---
1 for	---.-
2 for	----.-
3 for	---.---
4 for	-.-----

---



# REMOTE OPERATION OF THE MODEL DRC-91CA

## A & B

### Description

The A and B commands do the following:

1. Selects Filtering of the A or B inputs
2. Decides whether the Remote Position Data is used to establish the curve numbers
3. Determines the Temperature Coefficient for the 9215 card
4. Decides whether or not thermal correction is desired on the 9317C/9318C cards.
5. Selects Temperature Compensation for 9305 thermocouple card.

\*These commands act just like the Sensor ID switch, entered as two characters.

### Syntax

**Input** A[first byte] [second byte] or B[first byte] [second byte]

**[first byte]** hex representation of curve number or remote position. (See table below.)  
**[second byte]** hex combination of 9317C/9318C card thermal correction, digital filtering, 9305 card temperature compensation and 9215 card temperature coefficient. (See table below.)

Curve # or Remote Position Desired	First Byte Sent	Select Curve # or Remote Position	9317C/9318C Card Thermal Correction or 9305 Temperature Compensation	Digital Filtering	9215 Card Temperature Coefficient	Second Byte Sent
		←-----Second Byte Configuration-----→				
0	0	OFF (curve)	OFF	OFF	OFF (+)	0
1	1	OFF (curve)	OFF	OFF	ON (-)	1
2	2	OFF (curve)	OFF	ON	OFF (+)	2
3	3	OFF (curve)	OFF	ON	ON (-)	3
4	4	OFF (curve)	ON	OFF	OFF (+)	4
5	5	OFF (curve)	ON	OFF	ON (-)	5
6	6	OFF (curve)	ON	ON	OFF (+)	6
7	7	OFF (curve)	ON	ON	ON (-)	7
8	8	ON (position)	OFF	OFF	OFF (+)	8
9	9	ON (position)	OFF	OFF	ON (-)	9
10	A	ON (position)	OFF	ON	OFF (+)	A
11	B	ON (position)	OFF	ON	ON (-)	B
12	C	ON (position)	ON	OFF	OFF (+)	C
13	D	ON (position)	ON	OFF	ON (-)	D
14	E	ON (position)	ON	ON	OFF (+)	E
15	F	ON (position)	ON	ON	ON (-)	F

### Example

#### A10[term]

Enables the Remote Sensor ID. If the remote position data is 0, the sensor curve reverts to the curve in A00 (or B00) rather than being selected from the Remote Sensor ID Table.

#### A12[term]

Enables digital filtering in addition to the A10 description.

**Thermometry Queries**

**W1**

**Description** Provides the A and B input information.

**Syntax**

**Input** W1

**Returned** 32 Characters plus terminators

display sensor,control sensor,setpoint units,remote position,A ID,A curve number,A input resolution,A display units,B ID,B curve number,B input resolution,B input units

	# Of Characters	Form
Display Sensor	2	A0 - A4 and B0
Control Sensor	2	A0 - A4 and B0
Setpoint Units	1	K, C, F, V, N, R
Remote Position	2	00 through 1F
A ID	3	00 through FF
A Curve Number	2	00 through 31
A Input Resolution	1	0 through 4
A Display Units	1	K, C, F, V, N, R
B ID	3	00 through FF
B Curve Number	2	00 through 31
B Input Resolution	1	0 through 4
B Input Units	1	K, C, F, V, N, R

**Example** A0,B0,K,00,A20,02,3,K,B42,04,2,K[term]

The above string indicates that the Display Sensor is A0; Control Sensor B0; Setpoint is in kelvin; Sensor A ID is Filtering on; Curve assigned is 4; curve used is also 4; B resolution is 10mK; B units are also in Kelvin.

## WS

---

**Description** Gives the sample sensor reading.

**Syntax**

**Input** WS

**Returned** [sign] [sample sensor reading (6 characters including the decimal)] [units]

**Remarks** The decimal position will vary dependent on units and temperature.

**Example** +123.45K[term]

---

## WC

---

**Description** Gives the control sensor reading.

**Syntax**

**Input** WC

**Returned** [sign] [control sensor reading (6 characters including the decimal)] [units]

**Remarks** The decimal position will vary dependent on units and temperature.

**Example** +123.42K[term]

---

## W0

---

**Description** Provides the WS, WC and WP data strings with a single command.

**Syntax**

**Input** W0 *Note: 0 denotes zero.*

**Returned** [WS data string(8 characters)],[WC data string(8 characters)],[WP data string(8 characters)]

**Remarks** The decimal position will vary dependent on units and temperature.  
Total of 26 characters (*including commas*).

**Example** +123.45K,+123.42K,+123.4K[term]

## Scan Commands

These commands are used to configure the various functions of the scanning features.

---

# YS

---

**Description** Starts the scan of the inputs from the input channel which it is currently on.

**Syntax**

**Input** YS

**Remarks** When an 8229 Scanner Option is present, it is strongly recommended that the control channel be the B channel when using the scan function. If it is not, the control channel will be changed since one current source is used for all of the A0 through A4 inputs.

The instrument skips every channel with a dwell time of zero.

The dwell times should be set to at least 5 seconds to ensure a good reading for every card type.

The scan sequence with the 8229 Scanner Option Card is A0, A1, A2, A3, A4, B0, etc.

---

# YH

---

**Description** Stops the scan of the inputs.

**Syntax**

**Input** YH

**Remarks** The scanner should be on hold when any of the other scanner commands are sent to the scanner or unpredictable results could occur.

---

## YA & YB0

---

**Description** Sets the dwell time for a given channel.

**Syntax**

**Input** YA[channel][dwell time]  
or  
YB0[dwell time]

**[channel]** Fill in this parameter with 0 if no scanner is present.

Fill in the channel parameter with 0 through 4 if the 8229 Scanner Option is present.

**[dwell time]** Fill in the dwell time parameter with a value from 00 to 99. This value indicates seconds.

**Remarks** Setting the dwell time to 0 causes the channel be skipped in the sequence.

The dwell times should be set to at least 5 seconds to ensure a good reading for every card type.

**Example** YA125[term] selects channel A1 and sets the dwell time for 25 seconds.

---

## YCA

---

**Description** Selects scanner channels A0, A1, A2, A3 or A4.

**Syntax**

**Input** YCA[scanner channel]

**[scanner channel]** Fill in the scanner channel parameter with 0 through 4.

**Remarks** This command asynchronously selects a scanner channel for readout independent of the "scan" feature.

A1 through A4 are only available with the 8229 Scanner Card installed.

---

**Scan Queries**

---

**WY**

---

**Description** Returns the instrument scan status (scanning or holding), the channel dwell information and the scan position.

**Syntax**

**Input** WY

**Returned** [scan status],[A0 dwell time],[A1 dwell time],[A2 dwell time],[A3 dwell time],[A4 dwell time],[B0 dwell time],[scan position]

scan status	S for scanning or H for holding
channel dwell time	value returned for each channel is in seconds
scan position	current channel being scanned

**Example** S,05,05,00,00,00,10,A1[term]

This example indicates that the unit is currently scanning, channel A0 has a dwell time of 5 seconds, channel A1 is 5 seconds, A2 and A3 and A4 are skipped, channel B0's dwell time is 10 seconds and the current channel being scanned is A1.

---

## REMOTE OPERATION OF THE MODEL DRC-91CA

---

### Control Commands

These commands allow the interface to change any of the control parameters of the DRC-91CA.

---

## S

---

**Description** Used to set the setpoint.

### Syntax

**Input** S[setpoint]

**[setpoint]** For temperature units, fill in the setpoint parameter with a value from 0.0 to 999.9 (4 digits: 3 to the left of the decimal and one to the right).

For sensor units, fill in the setpoint with the appropriate value for the input card as described in the input card sections. (5 digits: the decimal point floats depending on the type of sensor input card).

**Remarks** A sign need only be present if negative celsius, fahrenheit or mV settings are desired.

If a temperature above the value permitted for the selected curve is entered, the setpoint is set to the upper temperature limit.

Unlike temperature units, limitations on the range of the setpoint are not possible for sensor units due to the different characteristics for each sensor.

### Example

If in kelvin:

1. **S123.4[term]** will result in a setpoint of 123.4 K.
2. **S75[term]** will result in a setpoint of 75.0 K.

If in voltage:

1. **S1[term]** will result in a setpoint of 1.0000V.
-

## REMOTE OPERATION OF THE MODEL DRC-91CA

---

---

### P

---

**Description** Allows entry of Gain

**Syntax**

**Input** P[*gain*]

**[*gain*]** Fill in the gain parameter with a value from 0.0 to 99.

**Remarks**

- The gain setting range is from 0.0 to 99 corresponding to a gain of 0 to 990. The actual gain is 10 times the setting.

- A gain of 0.0 turns the gain off.

**Example** P.1[*term*]  
Instructs the DRC-91CA to set a control gain of 0.1.

---

### D

---

**Description** Allows entry of Rate

**Syntax**

**Input** D[*rate*]

**[*rate*]** Fill in the rate parameter with a value from 0.0 to 99 seconds.

**Remarks** A rate of 0.0 turns the rate off.

---



## REMOTE OPERATION OF THE MODEL DRC-91CA

---

---

**Description** Allows setting of the Reset.

**Syntax**

**Input** I[reset]

**[reset]** Fill in the reset parameter with a value from 0.0 to 99.

**Remarks** The active reset setting range is from 0.1 to 99 corresponding to a reset time of 990 to 1 second.

A reset of 0.0 turns the reset off.

---

## R

---

**Description** Sets the heater range.

**Syntax**

**Input** R[heater range]

**[heater range]** Fill in the heater range parameter with a value from 0 to 5. (See table below.)

Heater Range	Front Panel Range Setting
0	OFF
1	OFF
2	-3
3	-2
4	-1
5	MAX

**Remarks** If the value is greater than 5, the instrument defaults to OFF.

---

**Control Queries**

---

**W3**

---

**Description** Provides the gain, rate, reset, heater range and % of heater power data.

**Syntax**

**Input** W3

**Returned** 17 characters plus terminators  
[Gain value (3 characters)],[Rate value (3 characters)],[Reset value (3 characters)],[Heater Range setting (1 character)],[% of Heater Power of Current out value (3 characters)]

**Remarks** Refer to the P, I, D and R Commands for values.

---

**WP**

---

**Description** Provides the setpoint reading.

**Syntax**

**Input** WP

**Returned** [sign][setpoint reading (6 characters including decimal)][units]

**Remarks** The decimal position will vary dependent on units and temperature.

**Example** +123.4 K[term]

---

# REMOTE OPERATION OF THE MODEL DRC-91CA

## Status Registers

### Status Byte Register and Service Request Enable Register

The Status Byte Register consists of a single byte of data containing six bits of information about the DRC-91CA's condition.

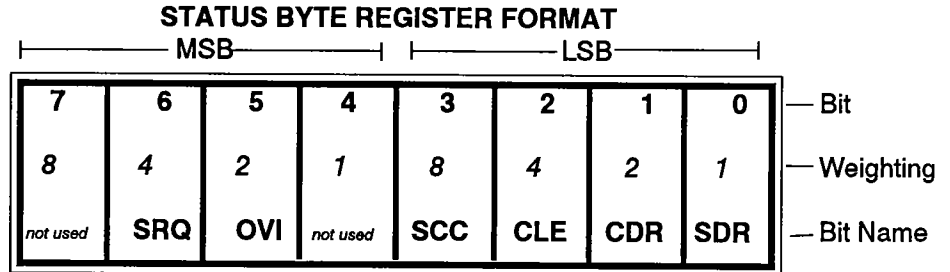

If the Service Request is enabled, any of the bits (0-5) being set will cause the unit to pull the SRQ management line low to signal the BUS CONTROLLER. These bits are reset to zero upon a serial poll of the Status Byte Register. These reports can be inhibited by turning their corresponding bits in the Service Request Enable Register to off.

The Service Request Enable Register allows the user to inhibit or enable any of the status reports in the Status Byte Register. If a bit in the Service Request Enable Register is set (1), then that function is enabled.

#### NOTE

*CLE Service Request operations and limits are designed to work in kelvin only. Any attempt to use temperature or sensor units besides kelvin will result in unpredictable operation. This also implies that the CLE can not be used with a 9215 sensor input card as it can only display in nF.*

**Service Request (SRQ) Bit (6)** determines whether the unit is to report via the SRQ line and four bits determine which status reports to make. If bits 0, 1, 2,3 and/or 5 are set, then the corresponding bit in the Status Byte Register will be set. The DRC-91CA will produce a service request only if bit 6 of the Service Request Enable Register is set. If disabled, the Status Byte Register can still be read by the BUS CONTROLLER by means of a serial poll (SPE) to examine the status reports, but the BUS CONTROLLER will not be interrupted by the Service Request. It must be understood that certain bits in the Status Byte Register are continually changing. The Standard Event Status Bit and the Status Reports for the Overload, Display Data Ready, and Control Data Ready are continuously updated to reflect current instrument status. The Control Channel Limit is latched (set to 1) and remains latched until the Status Byte Register is read.

The bit assignments are discussed below as they pertain to the Status Byte Register. These reports can only be made if they have been enabled in the Service Request Enable Register.

#### **Sample Data Ready (SDR) Bit (0)**

When this bit is set, a valid sample data reading is available.

#### **Control Data Ready (CDR) Bit (1)**

A valid control data reading is available when the CDR bit (1) is set.

## **REMOTE OPERATION OF THE MODEL DRC-91CA**

---

### **Control Limit Entered (CLE) Bit (2)**

This bit is set when the control sensor reading gets inside the chosen limit from the set point. The bit will not revert to zero if the reading falls back outside the chosen limit. If this report is read and the control sensor reading is still inside the limit, the CLE bit will be set again by the unit.

### **Sample Channel Change (SCC) Bit (3)**

Bit 3 of the status register is set when a channel change occurs for the sample sensor.

### **Overload Indicator (OVI) Bit (5)**

If the display has an overload condition on any selected channel, then this bit is set and a Service Request is issued if enabled.

# Q

**Description** Sets the Service Request Enable Register.

**Syntax**

**Input** Q[MSB][LSB][CLIM]

**[MSB]** Fill in the MSB parameter with:

MSB	Status Request Enable Register is
0	Service Request OFF; Error/Overload Indicator Request OFF
2 or 6	Error/Overload Indicator Request ON
4 or 6	Service Request is ON

**[LSB]** Fill in the LSB parameter with:

LSB	Status Request Enable Register Status is
0	Sample Data, Control Data and Limit OFF
1,3,5 or 7	Sample Data Service Request is ON
2,3,6 or 7	Control Data Service Request is ON
4,5,6 or 7	Control Channel Limit SRQ is ON

**[CLIM]** The control limit parameter is used to test the Control Limit Exceeded condition (CLE). The value is a difference from the setpoint in temperature. If the control limit (*Bit 2*) is selected, the limit **must** follow the Q command and is in a free field format or it will default to 0. If Bit 2 is not set, the limit **[CLIM]** should be left off.

Examples are ---., .-, --., --., -. , --., etc.

If Bit 2 of the Mask is set, then when the control sensor reading gets within the chosen limit from the set point, the corresponding bit is set in the Status Register.

The Status Register mask and control channel limit is part of the power-up save settings like the set point and units. It is updated on power-up to the last settings with internal switch 2 set. On power up the Status Register mask is set to 00 and the control channel limit to 000.0 if switch 2 is off.

**Example** Q06,000.1[term]  
 Enables the Control Data Ready and Control Channel Limit with a band of 0.1 about the control point. No SRQ interrupt will be generated because the SRQ bit is off.

# WQ

---

**Description** Returns the Service Request Enable Register and control channel limit information.

**Syntax**

**Input** WQ

**Returned** [Service Request Enable Register Byte (2 characters)],[Control Channel Limit band (4 characters)]

**Remarks** The Status Request Enable Register is saved at power-down, provided switch 2 of the internal 8 switch package is on (See page 3-5.).

- Example**
1. **61,000.0[term]** - Sample Data Ready with the Service Request bit on.  
With the SRQ bit of the Service Request Enable Register enabled, the DRC-91CA SRQ interrupt will be generated. The BUS CONTROLLER can read the Status Register to determine appropriate instrument conditions. In this case, bit 1 is continuously updated to reflect current instrument status of the Sample Data Ready. Q61 also results in a service request if an OVERLOAD/ERROR is indicated.
  2. **2F,000.1[term]** - All Status Reports and the SRQ bit off.  
With the SRQ bit of the Service Request Enable Register disabled, no SRQ interrupt by the DRC-91CA will be generated, however, the BUS CONTROLLER can still read the Status Register and this command will give all five Status Reports.
  3. **06,000.1[term]** - Enables the Control Data Ready and Control Channel Limit with a band of 0.1 about the control point.
-

# REMOTE OPERATION OF THE MODEL DRC-91CA

## Curve Commands

These commands allow the user to verify existing curves added at the factory or enter and delete user defined curves over the interface.

## XC\*

### Description

Enters a curve and all of the information surrounding it at a designated curve number location.

### Syntax

**Input** XC[curve number],[curve description],[data points]\*

**[curve number]** Fill in the curve parameter with an integer from 06 through 31.

**[curve description]** Fill in this parameter with up to 18 characters. It is an information line. At least one character is required and any more than 18 characters will be ignored. The first character should be blank or be an "L". An "L" tells the unit to perform Lagrangian calculations on the data. A blank space or any other character will tell the unit to perform straight line interpolation on the data.

The second character should be a number from 0-4 which describes the maximum temperature for the sensor. (0=325K, 1=375K, 2=475K, 3=799K, 4=999K)

The last 6 characters, of the 18 characters, are used as a capsule description of the curve and will be what is seen when the XDA and XDT commands are issued. We strongly recommend that the serial number be used here.

**[curve points]** The units/temp. data points must be input in ascending units. From 2 to 97 pairs can be input. The data points are input with the units value first. This value will be voltage or  $R_{equiv}$  (see page 4-35). The value will have one character before the decimal place and five after it (0.00000). The second value is the temperature. It has three characters before the decimal point and one after it (000.0).

After all points are input, placement of an "\*" terminates all sensor curve input.

### Remarks

The unit determines and stores whether the curve is a positive or negative temperature coefficient curve.

There can not be any spaces anywhere in the command string except for in the curve description.

Based on temperature coefficient, the unit then stores the curve end points. For a negative temperature coefficient curve, the first end point is 0.00000,499.9 and the last end point is 6.55360,000.0. For a positive temperature coefficient curve, the first end point is 0.00000,000.0 and the last end point is 6.55360,999.9.

Curves 06 through 31 are stored in Non-Volatile RAM (NOVRAM) . There are 3584 bytes free for the storage of curves. If the curve stored has 31 data points, it will take up 177 bytes. For this length curve, up to 20 curves can be stored in the unit. The XDT command can also be used in indicate how much space is free.

## **XE\***

---

**Description** Used to edit a data point in the sensor curve.

**Syntax**

**Input** XE[curve number][curvepoint]\*

**[curve number]** Fill in the curve parameter with an integer from 06 through 31. Data points can not be edited in standard curves 00 through 05.

**[curve point]** Fill in the point to be edited. It should be in the units/temperature combination. (See the XC command for further explanation.)

**Remarks** -If the DRC-91CA does not recognize either the units value or the temperature value, it will assume that you are inputting an entirely new point and place it in the proper ascending position.

**Example** If the point to be edited is in curve 12 and was input as 0.19083,364.0 and should have been 0.19083,365.0, simply use the command

**XE12,0.19083,365.0\*[term]**

The unit will recognize the units field and replace that data point with the new temperature value.

---

---

## **XK\***

---

**Description** Erases or kills the indicated sensor curve and repacks all curve data.

**Syntax**

**Input** XK[curve number]\*

**[curve number]** Fill in the curve number parameter with a value from 06 through 31.

**Remarks** Curves 00 through 05 can not be erased.

**Example** **XK28\*[term]**  
Erases curve 28.

---

---



## XA\* & XB\*

---

<b>Description</b>	Allow the user to set up the Correlation Table For Curve #
<b>Syntax</b>	
<b>Input</b>	XA[remote position]=[curve number]* or XB[remote position]=[curve number]*
<b>[remote position]</b>	Fill in the remote position parameter with a value of 00 through 09, 0A through 0F, 10 through 19, or 1A through 1F. (Refer to the Remote Position ID discussion in Section 3.
<b>[curve number]</b>	Fill in the curve number parameter with a value from 00 through 31.
<b>Remarks</b>	The correlation exists for both inputs but,, normally only one input would select the REMOTE SENSOR ID position data at a time.  Once the data has been changed, it is good practice to read out the changed table, using the XDT command and updating the Position # Versus Curve # Table in Section 3.

---

## XR&I\*

---

<b>Description</b>	This command is used to delete all internal curves and reinitialize the non-volatile memory. It should be used with caution. Curve data <u>will</u> be lost.
<b>Syntax</b>	
<b>Input</b>	XR&I* sent five times
<b>Remarks</b>	The command must be sent five times in succession. This prevents accidental deletion of internal curves.
<b>Example</b>	XR&I*XR&I*XR&I*XR&I*XR&I*[term]

---

**Curve Queries**

---

**XD**

---

**Description** Returns an individual curve, including the header line and all point information.

**Syntax**

**Input** XD[curve number]

**[curve number]** Fill in the curve number parameter with a value from 00 through 31.

**Returned** curve number(2 characters), curve description(18 characters),  
temperature coefficient(1 character), number of points(2 characters),  
units(7 characters), temperature(5 characters),

**Remarks** Information is one very long character string.

Minimum of 76 characters (for a curve with a minimum of 2 data points entered) and a maximum of 1406 characters (for a curve with a maximum of 97 data points), plus terminators.

For units, the format may not be what is on the display. See page 4-35 for the equivalent format.

**Example** 00, STANDARD DRC-D ,N,31,  
0.00000,499.9,0.19083,365.0,0.24739,345.0,  
0.36397,305.0,0.42019,285.0,0.47403,265.0,  
0.53960,240.0,0.59455,220.0,0.73582,170.0,  
0.84606,130.0,0.95327,090.0,1.00460,070.0,  
1.04070,055.0,1.07460,040.0,1.09020,034.0,  
1.09700,032.0,1.10580,030.0,1.11160,029.0,  
1.11900,028.0,1.13080,027.0,1.14860,026.0,  
1.07200,025.0,1.25070,023.0,1.35050,021.0,  
1.63590,017.0,1.76100,015.0,1.90660,013.0,  
2.11720,009.0,2.53660,003.0,2.59840,001.4,  
6.55360,000.0[term]

---

# XDT

---

**Description** Returns the standard Sensor Curves stored, the Precision Option Curves stored and the format associated with the REMOTE SENSOR ID Remote Position to Sensor Curve assignments.

**Syntax**

**Input** XDT

**Remarks** The instrument is shipped with all remote positions calling up Standard Curve 00 unless a precision option has been loaded at the factory.

The information lines for Sensor Curves 05 through 31 will only be present if these curves are actually present as either user generated curves or as Precision Option Curves.

There is a minimum of 321 characters (when only 6 standard curves are present) and a maximum of 805 characters (when all 32 curves are present) plus terminators.

**Example**

```
3584 BYTES FREE,0200 IS NEXT LOCATION,00,31,1D40,DRC-D,01,31,1DF0,  
DRC-E1,02,31,1EA0,CRV10,03,31,1F50,DINPT,04,31,2000,CRV10,05,31,20B0,RESVRD,  
00,00,00,00,00,00,00,00,00,00,00,00,00,00,00,00,00,00,00,00,00,00,00,00,00,00,  
00,00,00,00,00,00,00,00,00,00,00,00,00,00,00,00,00,00,00,00,00,00,00,00,00,  
00,00,00,00
```

---

# XDA

---

**Description** Returns the information from the XDT command listed above and the XD command for every sensor stored in the unit.

**Syntax**

**Input** XDA

**Returned** Same information from XDT command, a comma, same information from XD command for each sensor curve in ascending order. This will be a very long string of data.

---

# REMOTE OPERATION OF THE MODEL DRC-91CA

## Sample Programs

### HP86B Keyboard Interactive Program

The following program for the HP86B is an interactive program with the keyboard of the computer. For example, when the user sees the prompt on the screen and types in a valid DRC-91CA command such as "WO", the program will result in the display of the DRC-91CA showing up on the screen.

```
10 REM Set IEEE Address to 12
20 REM Address Switch 1 OPEN(0) to get (CR)(LF)
30 REM This program allows the user to communicate with the 91CA,
35 REM interactively from the computer keyboard
40 DIM A$(100)           ! Must be increased for curve information
50 INPUT B$              ! INPUT KEYBOARD COMMAND
60 OUTPUT 712 ;B$        ! SEND COMMAND TO 91CA
70 ENTER 712 ; A$        ! RECEIVE ANSWER FROM 91CA
80 DISP A$               ! DISPLAY ANSWER
90 GOTO 50
100 END
```

### National Instruments QUICK BASIC IBM Example

The following is the same program as listed above except in Quick Basic.

```
' IEEE-488 TEST PROGRAM Quick Basic 3.0 Example
' THIS PROGRAM WAS WRITTEN FOR THE NATIONAL INSTRUMENTS GPIB-PC2
' IEEE-488 CARD FOR IBM PC AND COMPATIBLES
' This program will allow the user to communicate with Lake Shore's
' instrument's interactively from the keyboard of an IBM compatible
' computer which has a National Instruments GPIB-PC2 installed and has
' dev 12 mapped to address 12.

      common shared IBSTA%, IBERR%, IBCNT%
      TEMP$="dev12"           'dev 12 mapped to address 12
      call IBFIND(TEMP$,TEMP%) 'Required command to address instrument
      A$=space$(1000)

Loop1:  input B$              'Entered from keyboard while running
        B$=B$+chr$(13)+chr$(10) 'Add CR and LF to command
        call IBWRT(TEMP%,B$)    'Send command to instrument
        call IBRD(TEMP%,A$)     'ENTER from instrument (SEE BELOW)
        FOR I = 1 to 10000
          C$ = MID$(A$, I,1)
          IF C$ = CHR$(13) THEN GOTO Loop2
          PRINT C$;
        NEXT I
Loop2:  PRINT
        A$ = space$(10000)      'Clear A$
        GOTO Loop1
      END

' Lake Shore Cryotronics instruments will return the data requested, but
' if the command input to the instrument does not request any information
' the instrument will respond with the information last requested.
```

## REMOTE OPERATION OF THE MODEL DRG-91CA

### Sensor Units Format for Curve Storage

When curves are stored inside of the instrument, the sensor units are converted to a voltage format (0.0000 to 6.5535). Temperature remains at 000.0 to 999.9K.

When entering curves or outputting curve data, use the table below to translate sensor data.

Sensor Input	Sensor Type	Units Range	Temp. Coeff.	Conversion for $R_{EQUIV}$ or Volts
9210-3 9220-3	Silicon Diodes	0-2.9999V	neg.	No conversion necessary.
9210-6 9220-6	GaAlAs Diodes	0-6.5535V	neg.	No conversion necessary.
9220-P2	100 $\Omega$ Pt RTD	0-299.99 $\Omega$	pos.	0.01 times R. 0.00 ohms looks like 0.00000 and 299.99 ohms looks like 2.99990.
9220-P3	1000 $\Omega$ Pt RTD	0-2999.9 $\Omega$	pos.	0.001 times R. 0.0 ohms looks like 0.00000 and 2999.9 ohms looks like 2.99990.
9220-R1	RhFe RTD	0-99.999 $\Omega$	pos.	0.03 times R 0.00 ohms looks like 0.00000 and 100.00 ohms looks like 3.00000.
9317C	Ge CGR	1-10,000 $\Omega$	neg.	Input must be in Log R. 1 ohm looks like 0.00000 and $10^4$ looks like 4.00000.
9318C	Ge CGR	1-100,000 $\Omega$	neg.	Input must be in Log R. 1 ohm looks like 0.00000 and $10^5$ looks like 5.00000.
9215-15	CS-401	0-15.000nF	N/A	No conversion is allowed.
9215-150	CS-501	0-150.00nF	N/A	No conversion is allowed.
9305	chromel-AuFe .07 &.03%, E,K,T	-15 to +15mV uncomp.	pos.	100 times ( $V_{TC} + 15mV$ ) -15mV looks like 0.0000V and +15mV looks like 3.0000.

# MODEL DRC-91CA TEMPERATURE CONTROLLER **5**

## INPUT/OPTION CARDS

In this section, you will learn about the various input and option cards. Included in the discussions of each card will be a description, installation, operation as well as additional text on any information specific to the particular card.

Input Card	Description	Page
9210	Diode Input Card	5-2
9220	Diode and Platinum Input Card	5-5
9317C/9318C	Resistance Input Card	5-8
9215	Capacitance Input Card	5-16
9305	Thermocouple Input Card	5-23

Option Card	Description	Page
8223	RS-232C Interface Option Card	5-32
8225	Analog Output Option Card	5-42
8229	Scanner Conversion Option Card	5-45

### Changing Configurations

Input cards 9210, 9215 and 9220 can easily have their configurations changed for the type of sensor desired.

Remove the top enclosure half following the instructions on page 5-3. Do not remove the calibration cover. Notice on the left side of the cover the heading SENSOR TYPE SELECT. The configurations possible are outlined in the table below. Simply push down the colored peg called for through the input card slot opening.

Input Card	Configuration	Peg Color
9210	-3 Silicon Diode	black
9210	-6 GaAlAs Diode	white
9215	-15 Capacitive (-15)	black
9215	-150 Capacitive (+15)	white
9220	-3 Silicon Diode	black
9220	-6 GaAlAs Diode	white
9220	-P2 100ohm Plat.	gray
9220	-P3 1000ohm Plat.	red
9220	-R1 Rhodium Iron	blue

#### NOTE

When a card is ordered for field installation, the Input Card Configuration Table located on the second page of the Instruction Manual should be updated to keep documentation current.

# THE MODEL DRC-91CA TEMPERATURE CONTROLLER INPUT/OPTION CARDS

## 9210 DIODE INPUT CARD

### Description

The Model 9210 Diode Input Card is designed to allow either the Input A or Input B (or both) to accommodate diode sensors. The 9210-3 is used with Lake Shore DT-500-DRC and DT-470 Series Sensors. Calibrated DT-500 or DT-470 Series Sensors can be accommodated with an 8000 Series Precision Option. The 9210-3 can be converted to 9210-6 configuration by pressing the white button on the Sensor Input Card. This configuration will also read DT-470 and DT-500 series sensors but with reduced resolution and accuracy.

The 9210-3 configuration will accommodate diode sensors with a voltage response of up to 3.0000 volts.

The 9210-6 configuration will accommodate diode sensors (TG-120 series) with a voltage response between 0 and 6.5535 volts. A calibrated sensor and 8001 Precision Option is required for the DRC-91CA or DRC-93CA to read accurately in temperature.

Refer to page 1 of this section for instruction on how to change configurations of this card.

### Specifications

The card can be configured as either a 3 volt (9210-3) or a 6 volt (9210-6) card.

<b>Sensor (ordered separately)</b>	DT-470 series, DT-500 series and TG-120 series from LSCI as well as any other diode sensor. See Lake Shore's Temperature Sensor Guide.
<b>Temperature Range</b>	Dependent on Diode Sensor. See Sensor Guide.
<b>Sensor Excitation</b>	DC current source. 10 microamperes (+0.005%). AC current noise less than 0.01% of DC current. Current Source compliance voltage - 7 volts
<b>Maximum Sensor Power Dissipation</b>	20 microwatts @ 4.2K for DT-470 Series. 25 microwatts @ 4.2K for DT-500 Series. Dissipation under other conditions is a product of Sensor Excitation Current and developed sensor voltage.
<b>9210-3:</b>	
<b>Input Voltage Range</b>	0 to 3 V
<b>Resolution</b>	0.05 millivolts (displayed to 0.1 mV in volts)
<b>Accuracy</b>	±0.18 millivolts
<b>Display Resolution</b>	5 digits. Displays 0.0000 to 2.9999 volts. Equivalent temperature accuracy is a function of sensor type, sensitivity and curve specification or Precision Option.
<b>9210-6:</b>	
<b>Input Voltage Range</b>	0-6.5535V
<b>Resolution</b>	0.1 millivolts
<b>Accuracy</b>	±0.36 millivolts
<b>Display Resolution</b>	5 digits. displays 0.0000 to 6.5535 volts. equivalent temperature accuracy is a function of sensor type and sensitivity. Precision Option required for TG-120 Sensors.

# THE MODEL DRC-91CA TEMPERATURE CONTROLLER INPUT/OPTION CARDS

## Installation

The 9210 can be installed in the DRC-91CA or DRC-93CA as either Input A or Input B (or both with two sensor input cards). The 9210 is factory installed if ordered with your Temperature Controller or can be field installed at a later date. If field installation is required, use the following procedure.

**WARNING** To prevent shock hazard, turn off the instrument and disconnect it from AC line power and all test equipment before removing cover.

1. Set the POWER switch to off and disconnect the power cord from the unit.
2. Remove the six screws on the sides of the top enclosure half and lift the cover off.
3. The calibration cover will now be seen.
4. Remove the calibration cover by taking out the six screws on the top of the cover (see page 2-5). Also, remove the two screws in the center of the rear panel of the instrument located near the top. Lift the cover off.
5. If an input card must be removed to make room for the new sensor input card, disconnect the wiring harness mating connector by lifting the locking tab on the input card connector and gently pulling on the body of the wiring harness mating connector. Lift card straight up to remove.
6. Plug the new 9210 Input Card into the A Input Card Slot 5 or the B Input Card Slot 6 with the component side to the left of the unit as viewed from the front.
7. Connect the wiring harness mating connector to the 9210 making sure that the wiring harness locking tab is seated over the extended edge of the wiring harness mating connector. Verify that the wiring harness is in place correctly by noting that the "A" or "B" on the harness mating connector is facing up (*if it is not, review the harness installation again*).
8. Thread the wiring harness along the rear edge of the unit and make sure that the harness is not binding or being pinched in any way.
9. Replace the calibration cover and the top enclosure half.

## Operation

The Model 9210-3 Diode Configuration provides the 10 microampere excitation current to the sensor. The resulting sensor voltage is digitized by a 16 bit A/D converter with a resolution of 50 microvolts and a full scale input voltage of 3.0000 volts (*100 microvolts and 6.5535 volts for the 9210-6 configuration*). The digitized value is converted to a serial data string and transferred to the main microprocessor using optical isolation. The sensor voltage is also buffered and transferred to the rear panel MONITORS connector for external monitoring as well as for control selection. For the 9210-3 configuration, the buffer voltage is multiplied by 1; for the 9210-6 configuration, it is multiplied by 0.457771 (3.0000/6.5535).



# THE MODEL DRC-91CA TEMPERATURE CONTROLLER INPUT/OPTION CARDS

## Calibration

The 9210 is calibrated to specification in the configuration specified prior to shipment. All configurations of the sensor input cards are calibrated to specification. The following equipment is used to calibrate the 9210 Diode Input Card:

- **Digital Voltmeter/Multimeter (DVM)** 4½ digit resolution or better.
- **Precision Standard Resistor** 100 kilohms with a tolerance of  $\pm 0.01\%$  or better.
- **Precision Voltage Source** capable of supplying a voltage with an accuracy and resolution of 100 microvolts out of 10 volts or better.

The unit should be allowed a one hour warm-up time to achieve rated specifications. Use the following procedure to calibrate the 9210 Diode Input Card.

1. Remove the top enclosure and not the calibration cover. See previous page.
2. **Set 10 $\mu$ A Current** - Connect the precision resistor across the A (+I) and B (-I) pins of the five pin input connector for the input the 9210 occupies. Connect the DVM plus lead to the +I pin and the minus lead to the -I pin. Adjust the trimpot marked 10 $\mu$ A (R17) on the calibration cover for the appropriate Input Card until the voltage across the resistor is  $1.0000 \pm 0.0001$  volts.
3. **Calibrate the Buffered Sensor Output Signal.** Connect the DVM plus lead to the +V Buffered Sensor Output Signal pin for the appropriate Input Card and the minus lead to the -V pin on the MONITORS connector. Connect the precision voltage source across the E (+V) and D (-V) pins of the five pin input connector for the appropriate input. Set the voltage standard to 1.5000 volts and adjust the trimpot marked B (R36) on the calibration cover until the DVM reads as close to 1.5000 volts as possible for the 9210-3 configuration and adjust the value to 0.68666 volts for the 9210-6 configuration.
- 4a. **Calibrate the A/D Converter (-3).** Verify that the Display selects the desired Input Card and that the units selected are V. Set the standard to 1.5000 volts for the 9210-3 and adjust the trimpot marked A/D (R29) until the display reads 1.5000 V. Check linearity by inputting 2.0000 and 1.0000 volts and verify that the unit displays those settings within  $\pm 0.0001$  volts. If this specification is not met, check the Technical Service Guide for further instructions.
- 4b. **Calibrate the A/D Converter (-6).** Verify that the Display selects the desired Input Card and that the units selected are V. Set the standard to 1.5000 volts for the 9210-6 and adjust the trimpot marked A/D (R36) until the display reads 1.5000 V. Check linearity by inputting 5.0000 and 1.0000 volts and verify that the unit displays those settings within  $\pm 0.0001$  volts. If this specification is not met, check the Technical Service Guide for further instructions.
5. Replace the top enclosure.

## Sensor Curve Information

Sensor Curve data for use with the 9210 Diode Input Card must be put in table form consisting of voltage and temperature points with the voltage in ascending voltage order. Refer to Section 4 of this manual for a discussion of how the data must be formatted for entry into the unit over the remote interfaces.

# THE MODEL DRC-91CA TEMPERATURE CONTROLLER INPUT/OPTION CARDS

## 9220 DIODE AND PLATINUM INPUT CARD

### Description

The Model 9220 Diode and Platinum Input Card is designed to convert either the Input A or Input B (or both) to accommodate either diode or positive temperature coefficient sensors such as platinum or rhodium-iron.

The 9220-3 configuration is equivalent to the 9210-3 configuration described earlier. The 9220-6 configuration is equivalent to the 9210-6 configuration.

The 9220-P2 converts either Input A or B (*or both*) to accommodate 100 ohm platinum RTD's which conform to DIN 43760 tolerances  $\pm 0.1K$ . They have an interchangeability of 0.1% at 0°C and a temperature coefficient of 0.00385/°C from 0 to 100°C when using the standard DIN curve. This card may also be configured as a 9220-P3 (1000 ohm platinum) or 9220-R1 (rhodium-iron) input card.

Refer to page 1 of this section for instruction on how to change configurations on this card.

### Specifications

The card can be configured as a 9220-3 or 9220-6 diode card, a 9220-P2 or 9220-P3 platinum card or a 9220-R1 rhodium-iron input card.

<b>9220-3</b>	See 9210-3 specifications.
<b>9220-6</b>	See 9210-6 specifications.
<b>Sensor (ordered separately):</b>	
<b>Platinum RTD sensor:</b>	PT-100 series or any other 100 ohm or 1000 ohm platinum sensor.
<b>27 ohm rhodium-iron sensor:</b>	See the Lake Shore Sensor Guide
<b>Temperature Range:</b>	Dependent on Sensor. See the Lake Shore Sensor Guide.
<b>RTD Sensor Power Dissipation:</b>	Depends on Sensor Resistance. Dissipation is the product of sensor excitation current squared and the Sensor resistance.
<b>9220-P2: 100 ohm platinum</b>	
<b>Current Excitation:</b>	1mA( $\pm 0.005\%$ )
<b>Resistance Range:</b>	0.00-299.99.
<b>Resolution:</b>	0.005 ohms
<b>Accuracy:</b>	$\pm 0.02$ ohms
<b>Display Resolution:</b>	5 digits. Displays 0.00 to 299.99 ohms.*
<b>9220-P3: 1000 ohm platinum</b>	
<b>Current Excitation:</b>	0.1mA( $\pm 0.005\%$ )
<b>Resistance Range:</b>	0.0 to 2999.9 .
<b>Resolution:</b>	0.05 ohms
<b>Accuracy:</b>	$\pm 0.2$ ohms
<b>Display Resolution:</b>	5 digits. Displays 0.0 to 2999.9 ohms.*
<b>9220-R1: 27 ohm platinum</b>	
<b>Current Excitation:</b>	3 mA( $\pm 0.005\%$ )
<b>Resistance Range:</b>	0.000 to 99.999
<b>Resolution:</b>	0.003 ohms
<b>Accuracy:</b>	$\pm 0.01$ ohms
<b>Display Resolution:</b>	5 digits. Displays 0.000 to 99.999 ohms.*

\* Equivalent temperature accuracy is a function of sensor type, sensitivity and Precision Option.

# THE MODEL DRC-91CA TEMPERATURE CONTROLLER INPUT/OPTION CARDS

## Installation

The 9220 can be installed in the DRC-91CA/DRC-93CA as either Input A or Input B (or both with two sensor input cards). The 9220 is factory installed if ordered with the Temperature Controller or can be field installed at a later date. If field installation is required, use the following procedure.

<b>WARNING</b>	<b>To prevent shock hazard, turn off the instrument and disconnect it from AC line power and all test equipment before removing cover.</b>
----------------	--

1. Set the POWER switch to off and disconnect the power cord from the unit.
2. Remove the six screws on the sides of the top enclosure half and lift the cover off.
3. The calibration cover will now be seen.
4. Remove the calibration cover by taking out the six screws on the top of the cover (see page 2-5). Also, remove the two screws in the center of the rear panel of the instrument located near the top. Lift the cover off.
5. If an input card must be removed to make room for the new sensor input card, disconnect the wiring harness mating connector by lifting the locking tab on the input card connector and gently pulling on the body of the wiring harness mating connector. Lift the card straight up to remove.
6. Plug the new 9220 Input Card into the A Input Card Slot or the B Input Card with the component side to the left of the unit as viewed from the front.
7. Connect the wiring harness mating connector to the 9220 making sure that the wiring harness locking tab is seated over the extended edge of the wiring harness mating connector. Verify that the wiring harness is in place correctly by noting that the "A" or "B" on the harness mating connector is facing up (if it is not, review the harness installation again).
8. Thread the wiring harness along the rear edge of the unit and make sure that the harness is not binding or being pinched in any way.
9. Replace the calibration cover and the top enclosure half.

## Operation

The 9220-3 and 9220-6 configurations are equivalent to the 9210-3 and 9210-6 configurations in terms of operation.

The Model 9220-P2 Configuration provides the 1 milliamper excitation current to the platinum sensor (the 9220-P3 supplies 0.1 milliamper and the 9220-R1 supplies 3 milliamperes). The resulting sensor voltage is amplified by a factor of -10 (negative 10) and digitized by a 16 bit A/D converter with a resolution of better than 100 microvolts out of 3.0000 volts full scale. The digitized value is converted to a serial data string and transferred to the main microprocessor using optical isolation. The amplified (-10) sensor voltage is transferred to the J3 MONITORS connector for external monitoring.

# THE MODEL DRC-91CA TEMPERATURE CONTROLLER INPUT/OPTION CARDS

## Calibration

The 9220 was calibrated to specification prior to shipment. If recalibration is needed, refer to the following procedure. The following equipment is used to calibrate the 9220 Input Card:

- **Digital Voltmeter/Multimeter (DVM)** 4½ digit resolution or better.
- **Precision Standard Resistor** 1 kilohms for 9220-P3 or 100 ohms for 9220-P2 and 9220-R1 with a tolerance of +/- 0.01% or better.
- **Precision Voltage Source** capable of supplying a voltage with an accuracy and resolution of 10 microvolts out of 1 volt or better.

The unit should be allowed a one hour warm-up time to achieve rated specifications.

Refer to the 9210 section for the calibration procedure for the 9220-3 and 9220-6 configurations.

Use the following procedure to calibrate the 9220-P2, -P3 and -R1 Configurations.

1. Remove the top enclosure half following the steps on page 5-6.
2. Follow the calibration steps for the 9210 on page 5-4.
3. **Set .1mA, 1mA, 3mA Current** - Connect the appropriate precision resistor across the A (+I) and B (-I) pins of the five pin input connector for the input (J1 or J2) the 9220 occupies. Connect the DVM plus lead to the +I pin and the minus lead to the -I pin. Adjust the trimpot marked **1mA (R4)** (for -P2) on the calibration cover (**.1mA (R5)** for -P3, **(R6) 3mA** for -R1) for the appropriate Input Card until the voltage across the resistor is equal to the sensor current times the resistance  $\pm$  the tolerance of the resistor. (*Press the appropriate button for the range being calibrated.*)
4. **Calibrate the Input -10 Amplifier** -Connect the DVM plus and minus leads to the + V and -V Sensor Output Signal pins for the appropriate Input Card of the J3 MONITORS connector. Connect the precision voltage source across the E(+V) and D(-V) of J1 INPUT A or J2 INPUT B for the appropriate input and set the standard to 0.0000 volts. Adjust the trimpot marked **AMP Z (R38)** on the calibration cover until the DVM reads as close to 0 volts as possible. Set the standard to 0.2500 volts and adjust the trimpot marked **AMP S (R11)** on the calibration cover until the voltage reads -2.5000 volts. Recheck the **AMP Z**.
5. Replace the top enclosure half.

## Sensor Curve Information

Sensor Curve data for use with the 9220 RTD Configurations must be put in table form consisting of voltage and temperature points with the voltage in ascending voltage order. Since the 9220 raw data would be in resistance form, it must be converted prior to entering. Refer to Section 4 of this manual for a discussion of how the data must be converted and formatted for entry into the unit over the remote interface.

## 9317C/9318C RESISTANCE INPUT CARD

### Description

The 9317C/9318C can be used with germanium, carbon glass or carbon resistors or any other negative temperature coefficient resistors.

The Model 9317C/9318C Resistance Input Card is designed to be installed in a DRC-91CA/ DRC-93CA to convert either Input A or Input B (or both) to accommodate sensors where the voltage level must be kept at levels on the order of 1 or 10 millivolts and where a thermal voltage may exist. Both cards read in ohms from a full scale reading of 10 ohms with 1 milliohm resolution to a full scale reading of 10,000 ohms with 0.1 ohm resolution for the 9317C and 100,000 ohms with 1 ohm resolution for the 9318C. To read temperature accurately, a calibrated sensor and an 8000 Series Precision Option is required.

### Specifications

<b>Input Range</b>	
<b>9317C</b>	Less than 1 ohm to 10,000 ohms with a resolution of 1 part in 10,000 and an accuracy of 0.1% of reading for resistances from to 1,000 ohms and 0.5% of range for resistances from 1,000 to 10,000 ohms.
<b>9318C</b>	Less than 1 ohm to 100,000 ohms with a resolution of 1 part in 10,000 and an accuracy of 0.05% of reading for resistances from 10 to 10,000 ohms and 0.25% of range for resistances less than 10 ohms and from 10,000 to 100,000 ohms.
<b>Sensor Excitation</b>	Current range is from 0.1 microampere to 1 milliampere. The current is varied automatically to maintain the voltage across the sensor at approximately 1 millivolt for the 9317C and approximately 10 millivolts for the 9318C. Current polarity is periodically reversed to allow for automatic digital correction for thermal EMFs in the sensor connections and leads.
<b>Maximum Sensor Power Dissipation</b>	Depends on sensor resistance. Voltage applied is approximately 1 millivolt for the 9317C (power is $1/R$ in micro-watts) or approximately 10 millivolts for the 9318C (power is $100/R$ in microwatts).
<b>Sensors</b>	Card optimized for CGR Series Carbon Glass or GR Series Germanium Resistance Thermometers. Other negative temperature coefficient resistors (such as thermistors) can also be used. <i>(Ordered Separately)</i>
<b>Sensor Response Curve</b>	The unit displays resistance in ohms directly. A calibrated sensor and an 8001 Precision Option curve generated using Lake Shore's proprietary Polynomial Interpolation Algorithm are required for the unit to display temperature accurately.
<b>Input Resistance</b>	Greater than $10^9$ ohms
<b>Display Resolution</b>	5 digits. Displays 0.000 to 9999.9 ohms for the 9317C and 0.000 to 99999. ohms for the 9318C. Resultant temperature accuracy is a function of sensor characteristic and is the product of the input accuracy (in percent) times $R$ ( $dT/dR$ ) plus any transfer inaccuracy introduced by the sensor response curve.
<b>Temperature Control Signal</b>	Card generates an analog voltage output signal which is related to the sensor temperature. The instrument generates a similarly related set point voltage based on the set point resistance or temperature selected. Real-time analog comparison of these two voltages provides the required control signal.

# THE MODEL DRC-91CA TEMPERATURE CONTROLLER INPUT/OPTION CARDS

## Installation

The 9317C/9318C can be installed in a DRC-93CA as either Input A or Input B (or both with two cards). The 9317C/9318C is installed prior to shipment if ordered. If only one 9317C/9318C is ordered and its input is not specified when ordered, it is installed in Input A.

Use the following procedure for the installation of the 9317C/9318C Resistance Input Card.

### WARNING

To prevent shock hazard, turn off the instrument and disconnect it from AC line power and all test equipment before removing cover.

1. Set the POWER switch to off and disconnect the power cord from the unit.
2. Remove the six screws on the sides of the top enclosure half and lift the cover off.
3. The calibration cover will now be seen.
4. Remove the calibration cover by taking out the six screws on the top of the cover (see page 2-5). Also, remove the two screws in the center of the rear panel of the instrument located near the top. Lift the cover off.
5. If an input card must be removed to make room for the new sensor input card, disconnect the wiring harness mating connector by lifting the locking tab on the input card connector and gently pulling on the body of the wiring harness mating connector. Lift the card straight up to remove.
6. Plug the new 9317C/9318C Input Card into the A Input Card Slot or the B Input Card with the component side to the left of the unit as viewed from the front.
7. Connect the wiring harness mating connector to the 9317C/9318C making sure that the wiring harness locking tab is seated over the extended edge of the wiring harness mating connector. Verify that the wiring harness is in place correctly by noting that the "A" or "B" on the harness mating connector is facing up (if it is not, review the harness installation again).
8. Thread the wiring harness along the rear edge of the unit and make sure that the harness is not binding or being pinched in any way.
9. Replace the calibration cover and the top enclosure half.

# THE MODEL DRC-91CA TEMPERATURE CONTROLLER INPUT/OPTION CARDS

---

## Operation

The 9317C/9318C is a highly complex, microprocessor controlled Sensor Input Card. Its resistance measuring technique is distinctly different from the way a DMM would measure resistance. Most DMMs force a large enough signal across the device being measured to make any thermal offset negligible. Using this method in a cryogenic environment could add a significant amount of power, in the form of sensor self heating, to the test system. The 9317C/9318C Input Card limits the amount of power added to the system by limiting the voltage across the sensor to approximately 1 (9317C) or 10 millivolts (9318C). The 9317C/9318C can also reverse the current polarity in order to correct for thermal EMFs in the sensor connections and leads.

The 9317C/9318C current source has four ranges: 0.1 to 1 microamperes (Range 1), 1 to 10 microamperes (Range 2), 10 to 100 microamperes (Range 3) and 100 to 1000 microamperes (Range 4). Each range has 64 independent current values. The ranges overlap each other (*i.e.*, Range 1 - Value 60 is equivalent to Range 2 - Value 6) so that a smooth transition from range to range can be made. The current value, as well as direction, is controlled by a 16 bit bipolar D/A converter. This current resolution is required to maintain as close to 0.95 (9317C) or 9.5 (9318C) millivolts across the sensor as possible. The on-card microprocessor stores calibration constants for each of the four ranges at the end point values of 6 and 60 for both the positive and negative directions (*a total of 16 current calibration constants in all*).

The resulting sensor voltage is converted from a differential to single ended signal and amplified by a factor of 1000 (9317C) or 100 (9318C). The amplified signal is digitized by a microprocessor controlled 15 bit A/D converter. The microprocessor also has calibration constants stored for the gain and offset of the input amplifier. As a result of the A/D resolution and calibration constant manipulation of the sensor signal, the sensor signal can be digitized with a resolution of 1 part in 10,000 over most of the resistance range that the 9317C/9318C covers. There is also a sample-and-hold network on the card so that when the sensor signal is reversed for thermal correction while controlling, the correct polarity of the control signal is maintained.

## **Thermal Correction Selection For The DRC-91CA**



The control thermal correction function is enabled or disabled using switch 3 of the appropriate SENSOR ID switch located on the rear panel.







When switch 3 of the SENSOR ID switch is closed (on), the thermal correction is enabled. When switch 3 is open (off), the thermal correction is disabled. Pressing the LOCAL key for the appropriate channel will display either  $\pm 18$  C or  $\pm 17$  C. Plus indicates that the control thermal correction is enabled while minus indicates that it is disabled.

Thermal correction is always active in sample mode. Thermal correction, in control mode, is only active when SENSOR ID switch 3 is on and the temperature reading is close to the setpoint. When these two conditions are met, a thermal correction occurs approximately once every two minutes.

## **Thermal Correction Selection For The DRC-93CA**

When a 9317C/9318C Resistance Input Card is installed, pressing the SENSOR key will display either  $\pm 9317$ C or  $\pm 9318$ C for the appropriate channel. Plus indicates that the control thermal correction is enabled while minus indicates that it is disabled.

Enable or disable the control thermal correction from the front panel by using a combination of the SENSOR, ,  and  keys as follows:

1. Press and hold the SENSOR key.
2. While holding the SENSOR key, press the  key. Release the SENSOR key. Do not release the  key.
3. To change the sign (*i.e., change the enabled/disabled status*) of the upper display, press the  key. Similarly, to change the sign of the lower display, press the  key.
4. Release the  or  key, then the  key.
5. Press the SENSOR key to verify that the proper sign is selected.



## **THE MODEL DRC-91CA TEMPERATURE CONTROLLER INPUT/OPTION CARDS**

### **Operation as the Sample Input**

When the input occupied by the 9317C/9318C is selected as the Sample Input (*Sample only -not Control*), the 9317C/9318C determines the sample resistance by forcing the voltage across the sensor to 0.95 (9317C) or 9.5 (9318C) millivolts as quickly as possible with the microprocessor controlled current source. Once the forward current range and value results in the desired voltage, the current is reversed and the thermal value determined. As long as the voltage across the sensor does not change more than 0.5% of reading from one reading to the next, the forward and reverse readings are taken each time the input card is asked for an update (*approximately once a second*) and a new thermal value is determined. If the voltage changes more than 0.5% of reading, the card stops reversing the current and uses the thermal value previously determined until the sensor signal stabilizes.

### **Operation as the Control Input**

When the input occupied by the 9317C/9318C is selected as the Control Input (*Control only, or Sample and Control*) the operation of the card changes. Since the card has to provide a signal across the sensor that will control the heater power as well as measure resistance (*or temperature*), it can no longer force the sensor signal to 0.95 or 9.5 millivolts immediately.

When a set point is entered, the unit calculates its equivalent control sensor resistance. From this resistance and the calibration constants (*current and voltage*) for the 9317C/9318C input card, the set point voltage which will result in a sensor voltage as close to 0.95 or 9.5 millivolts as possible (*when the control point is reached*) is calculated. If the thermal correction is active (*switch 3 of the SENSOR ID for the is CLOSED (ON) or has been enabled from the front panel of the unit*) and there has been a valid thermal value determined, it is included in the calculation. If no valid thermal has been determined, or the thermal correction is inactive or has been disabled from the SENSOR ID switch 3 of the unit, a thermal value of 0 is used. The resultant voltage is then sent to the main board of the controller as the set point voltage (*or equivalent "resistance"*) for control.

The 9317C/9318C input card then determines if the control sensor resistance is above or below the equivalent set point "resistance". If the actual resistance is less than the set point "resistance", an over-temperature condition exists and the heater power should be off. The 9317C/9318C changes the current it applies to the sensor in order to maintain between 0.8 and 1.0 (9317C) or 8 and 10 (9318C) millivolts across it until the set point current range and value have been reached. In this way, the heater remains off until the actual sensor resistance approaches the set point "resistance". Once the final control sensor current value has been reached, the 9317C/9318C allows the sensor voltage to range as high as 1.3 (9317C) or 13 (9318C) millivolts. If the sensor voltage (*and the equivalent resistance*) continues to increase, an under-temperature condition exists. The 9317C/9318C then reduces the current to maintain between 1.1 and 1.3 (9317C) or 11 and 13 (9318C) millivolts across the sensor. The heater power remains on. Even though this operation takes the sensor voltage away from the optimum signal until it reaches the control point, the resulting error in the resistance determination is small. If the new set point results in an under-temperature condition, the opposite operation is performed.

If the thermal correction is active, the unit monitors the sensor resistance until it is within 0.5% of the set point resistance. Once it is, the DRC-91CA/DRC-93CA signals the 9317C/9318C card to reverse the sensor current and update the thermal value. The 9317C/9318C card and the DRC-91CA/DRC-93CA use this new thermal to determine the resistance and correct the set point. The thermal value is updated every 120 instrument update cycles (*about 2 minutes*) after the initial update. When the set point is changed, the previous thermal value is used until the correction criteria is met and the thermal updated again.

# THE MODEL DRC-91CA TEMPERATURE CONTROLLER INPUT/OPTION CARDS

## Calibration

The design of the 9317C/9318C Resistance Input Card is such that recalibration should not be required more often than every six to twelve months in order to keep the card within its accuracy specification. However, if recalibration is required, the following equipment is needed:

<b>Digital Voltmeter (DVM)</b>	5 1/2 digit resolution or better.
<b>Five (5) Precision Standard Resistors</b>	which are accurate in value to at least 0.01%. Their values in ohms must be: 9317C: 1, 10, 100, 1K, 10K 9318C: 10, 100, 1K, 10K, 100K
<b>Precision Voltage Standard</b>	capable of a plus and minus 10 millivolt signal to within $\pm 0.1$ microvolt.

Since very often these values will not be available to the user of this instrument, Lake Shore Cryotronics, Inc. offers a recalibration service. Contact a factory representative for information concerning recalibration.

### NOTE

*The card believes that the correct resistance and voltage is applied during calibration. Therefore the accuracy of the calibration depends on the accuracy of the standards used.*

The unit should be allowed a one hour warm-up time to achieve rated specifications. References are made in the calibration procedure to eight calibration switches, CAL 8 through CAL 1. Refer to the table on page 5-15 for the hardware switch definitions of CAL 8 through CAL 1. References are made to test points, adjustments and calibration switches that are labeled on the calibration cover. Use the following procedure to calibrate the 9317C/9318C Resistance Input Card.

1. Remove the top enclosure half following the steps on page 5-9.
2. Configure the input that contains the 9317C/9318C as the SAMPLE input only and make the units ohms. Turn off Digital Filtering and Thermal Correction DIP switches of the appropriate SENSOR ID (*switches 2 and 3 to the OPEN [OFF]*) for the DRC-91CA or disable from the front panel on the DRC-93CA.
3. **Current Source Zero** - Connect the 10K (9317C) ohm precision resistor across the +I and -I pins of the Resistance Input Card input connector and enable both CAL 8 and CAL 7 of the card. Attach the plus and minus leads of the DVM to the test points marked (TP2) V+ and (TP1) V-respectively of the 9317C/9318C PCB and adjust the trimpot marked (R26) IZ so that the voltage reads as close to zero as possible. If this voltage is not close to zero, it may affect the sensor current setting. Consequently, this operation should be performed before any current calibrations are performed. Disable CAL 7 and continue. Note that CAL 8 will remain enabled for all calibration operations.
- 4a. **Voltage Match or Span** - Connect the DVM plus and minus leads to the V+ and V-Sensor Output Signal terminals of the MONITORS connector for the input being calibrated. Apply a +1 (9317C) or +10 (9318C) millivolt signal to the +V and -V Sensor Input terminals. Enable CAL 6 on the card (CAL 8 is still enabled). The DVM should read about 1 volt and the display of the unit should read approximately 10000. Adjust the trimpot labeled A/D (R17) so that the voltage read on the DVM matches the display of the unit (if the DVM reads 1.0085 make the display read 10085.). If the trimpot is adjusted wait a minimum of 10 readings before disabling CAL 6.

## **THE MODEL DRC-91CA TEMPERATURE CONTROLLER INPUT/OPTION CARDS**

---

- 4b. Apply a -1 (9317C) or -10 (9318C) millivolt signal to the input and enable CAL 5. Do not adjust any of the trim pots. Disable CAL 5 after approximately 30 seconds. When the display goes to 0., the unit has completed determining the voltage input calibration constants and has stored them in the 9317C/9318C calibration EEPROM.
5. **Current Range 1, Value 6** - Configure the 10K (9317C) or 100K (9318C) resistor to simulate the sensor. Enable CAL 4 and monitor the unit's display. The display should indicate the number 106. for approximately 30 seconds and then display 0. indicating the end of the calibration. Disable CAL 4 and continue.
6. **Current Range 1, Value 60 and Current Range 2, Value 6** - Substitute a 1K (9317C) or 10K (9318C) resistor for the previous resistor and re-enable CAL 4. The display will display the number 160. for approximately 30 seconds, then the number 206. for another 30 seconds and when complete, a 0. will be displayed. Disable CAL 4 and continue.
7. **Current Range 2, Value 60 and Current Range 3, Value 6** - Substitute a 100 ohm (9317C) or 1K (9318C) resistor for the previous resistor and enable CAL 3. The display will indicate 260. for approximately 30 seconds, then 306. for another 30 seconds and finally a 0. Disable CAL 3 and continue.
8. **Current Range 3, Value 60 and Current Range 4, Value 6** - Substitute a 10 ohm (9317C) or 100 ohm (9318C) resistor for the previous resistor and enable CAL 2. The display will indicate 360. then 406. with each time period being approximately 30 seconds. When the 0. appears, disable CAL 2 and continue.
9. **Current Range 4, Value 60** - Finally substitute the 1 ohm (9317C) or 10 ohm (9318C) resistor for the previous resistor and enable the last switch, CAL 1. The display will indicate 460. for approximately 30 seconds and then a 0. indicating that the calibration of the card is complete. Disable CAL 1 and then CAL 8.
10. Power down the instrument and then power it back up. This allows the data contained in the EEPROM mask Ram to be down loaded into the non volatile portion of the EEPROM.
11. **Set Point D/A Calibration** - A special set point calibration is required for a DRC-91CA/DRC-91CA with two 9317C/9318C Input Cards or if the 9317C/9318C is the only Input Card. Since the set point voltage is related to the set point resistance, and is determined with the individual card calibration constants, there is no way to enter a set point that results in a pre-determined value for the set point. The Internal ID Switch (S7 on the Main Board) is used in the calibration. Note the position of the Internal ID switches before proceeding. Attach the plus and minus leads of the DVM to TP25(SP V) and TP1(GND(2s)) respectively of the Calibration and Service Card. Make switch 7 CLOSED (ON). This forces the unit to output a set point of 0 volts. Adjust the SP ZERO ADJ trimpot until the DVM reads as close to zero as possible. Turn ON switch 6 of the Internal ID. This forces the unit to output a set point of -2.7 volts. Adjust the SP SPAN ADJ trimpot until the DVM reads as close to -2.7000 volts as possible. This procedure should be done until the 0 and -2.7 readings are as close as possible to the calibration values. Before returning to normal operation, make sure switches 7 and 6 of the Internal ID are OPEN (OFF).
12. Replace the top enclosure half.

# THE MODEL DRC-91CA TEMPERATURE CONTROLLER INPUT/OPTION CARDS

## Sensor Curve Information

The 8000 series precision options used with the 9317C/9318C Input Card are generated using a proprietary Polynomial Interpolation Algorithm developed by Lake Shore. The format for the data to be stored using the XC command is the same as for a standard curve except the resistance is converted to a LOG value (*where 1000 ohms would look like 4.0000*). Refer to the XC Command in Section 4. for a definition of the curve requirements. The curve data is in resistance order. The resistance and temperatures for the 9317C/9318C are in ohms up to 100,000 ohms and in kelvin up to 399.9

## Calibration Switch Definitions

Viewed through Calibration Cover

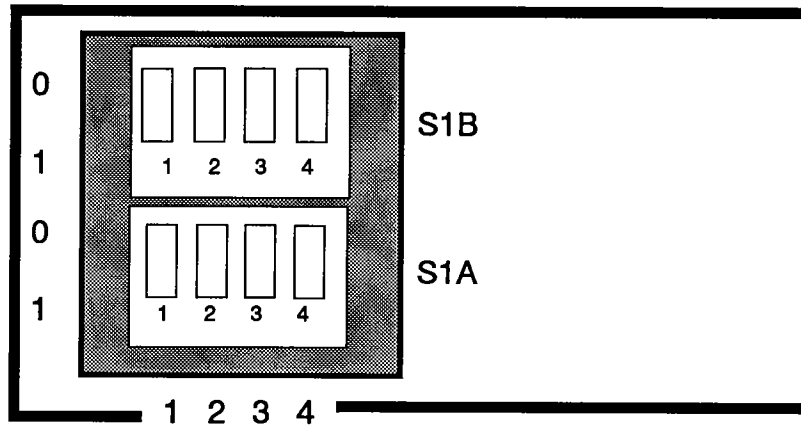

Switch	CAL	Definition (switch closed)		
S1A-4	8	Calibration Enable		
S1A-3	7	Current Source DAC Zero		
		9317C	9318C	
S1A-2	6	+1mV	+10mV	Input A/D Cal
S1A-1	5	-1mV	-10mV	Input A/D Verify
S1B-4	4	1K/10K	10K/100K	Current Verify
S1B-3	3	100 ohm	1K ohm	Current Verify
S1B-2	2	10 ohm	100 ohm	Current Verify
S1B-1	1	1 ohm	10 ohm	Current Verify

# THE MODEL DRC-91CA TEMPERATURE CONTROLLER INPUT/OPTION CARDS

## 9215 CAPACITANCE INPUT CARD

### Description

The Model 9215 Capacitance Input Card is designed to allow either Input A or Input B to accommodate capacitance sensors. When used to control temperature in magnetic fields, the capacitance sensor is superior to other sensors since the displacement current in a capacitor is magnetic field independent. Accurate temperature readings require the use of another type of sensor in zero magnetic field. This accurate sensor can be placed in the other Input Slot of the DRC-91CA/DRC-93CA.

The card can be configured by the user as either a 15 nanofard (9215-15) or a 150 nanofard (9215-150) card by switches on the card. (See page 5-1.)

The 9215-15 configuration is used with capacitance sensors with a maximum of 30 nanofarads (for example, Lake Shore CS-401 Series Sensors).

The 9215-150 configuration will accommodate capacitance sensors of up to 150 nanofarads (for example, Lake Shore CS-501 Series).

### Specifications

<b>Display Resolution</b>	5 digits
<b>Display Units</b>	Capacitance in nanofarads
<b>Temperature Accuracy</b>	Unit supports capacitance only. No temperature conversion.
<b>Sign of Temperature Coeff.</b>	User Selectable by Keys or Computer Interface
<b>Magnetic Field Sensitivity</b>	< $\pm 0.15\%$ for B < 19 Tesla and T > 4.2K.
<b>9215-15:</b>	
<b>Sensor Excitation</b>	5 kilohertz charging current
<b>Specified Range</b>	0-15 nF
<b>Range Limit</b>	0-30 nF with reduced accuracy
<b>Sensor</b>	CS-401 Series from LSCI or other Capacitance Sensor (ordered separately)
<b>Resolution</b>	0.001 nF
<b>Accuracy</b>	0.25% of Full Scale
<b>Analog Output Signal</b>	0.1 times capacitance (nF) in volts
<b>9215-150:</b>	
<b>Sensor Excitation</b>	1 kilohertz charging current
<b>Specified Range</b>	0-150 nF
<b>Range Limit</b>	0-300 nF with reduced accuracy
<b>Sensor</b>	CS-501 Series from LSCI or other Capacitance Sensor (ordered separately)
<b>Resolution</b>	0.01 nF
<b>Accuracy</b>	$\pm 0.25\%$ of Full Scale
<b>Analog Output Signal</b>	0.02 times capacitance (nF) in volts

#### NOTE

Calibration for zero capacitance may be required to meet accuracy specifications if your sensor lead capacitance or stray capacitance is excessive.

## Notes on CS-501 Capacitance Sensors

### Short-Term Stability

The capacitance sensor provides very stable temperature control over long periods of time. However, since an operational "aging" phenomenon exists some care must be exercised in their use. The short-term (*minutes to hours*) capacitance/temperature drift is initiated by a thermal perturbation of the sensor.

In order to minimize this short-term drift, it is recommended that approximately one hour be allowed for the sensor to stabilize after the initial cooldown. The short-term drift is then on the order of a few tenths of millikelvin/minute at 4.2K, several millikelvin/minute at 77K and one millikelvin/minute at 305K. For temperatures less than 290K, the short-term drift is such that the equivalent temperature will decrease with time and for temperatures above 290K will increase with time.

### Thermal Cycling and Reproducibility

Thermal cycling of capacitance sensors can produce variations in capacitance/temperature values equivalent to several tenths of a degree over the short term (*days*). Thermal cycling over the long term (*weeks*) can result in variations that exceed a degree. These variations are always such that the equivalent temperature increases with time and with increased cycling. The reduced capacitance  $C(T)/C(4.2K)$  for  $T < 290K$  is stable to within  $\pm 0.5K$  on the average. Also these variations do not create instabilities and do not impair the sensors primary function as a control device in magnetic fields.

They also are not seen within a temperature cycle.

### Magnetic Field Dependency

Magnetic field sensitivity is less than  $\pm 0.15\%$  at 4.2K and less than  $\pm 0.05\%$  between 77K and 305K for fields up to 18.7 Tesla.

### Frequency Dependence

For frequencies between 1 and 5 kilohertz the frequency sensitivity is as follows:

- 0.18K/kilohertz at 4.2K
- 1K/kilohertz at 77K
- +0.06K/kilohertz at 305K

# THE MODEL DRC-91CA TEMPERATURE CONTROLLER INPUT/OPTION CARDS

Typical Temperature Ranges and Sensitivities

Sensor Type	T (K)	C (nF)	dC/dT (pf/K)
CS401GR-A* (1184)	4.2	1.7609	20.77
	20.0	2.0347	15.30
	60.0	2.4227	2.42
	80.0	2.3544	-9.14
	140.0	1.4847	-12.91
	200.0	0.9445	-5.95
	295.0	0.6307	-1.83
CS-401GR-B* (1186)	4.2	5.3155	65.22
	20.0	6.1118	44.63
	60.0	7.2357	7.38
	80.0	7.0525	-25.61
	140.0	4.5379	-38.46
	200.0	2.9062	-18.10
	270.0	2.1054	-7.07
295.0	1.9492	-5.55	
CS-401LG-B*	***	***	***
CS-401LG-C* (1248)	4.2	11.1972	137.0
	20.0	12.9423	94.8
	60.0	15.3912	21.2
	80.0	14.9303	-60.7
	140.0	9.3561	-81.3
	200.0	5.9762	-37.1
	270.0	4.3180	-14.0
295.0	3.9989	-12.2	
CS-501** (10002)	4.4	6.5884	30.74
	20.0	7.1334	37.61
	60.0	9.0452	56.19
	80.0	10.1940	57.52
	140.0	14.0355	82.44
	200.0	21.7233	197.4
	270.0	91.0746	4025.0
295.0	130.140	-1226.0	

\* 9215-15 configuration

\*\* 9215-150 configuration

\*\*\* No calibration data available.

# THE MODEL DRC-91CA TEMPERATURE CONTROLLER INPUT/OPTION CARDS

## Installation

The 9215 can be installed in the DRC-91CA/DRC-93CA as either Input A or Input B. The card is factory installed if ordered with a Temperature Controller or can be field installed at a later date. If field installation is required, use the following procedure.

**WARNING** To prevent shock hazard, turn off the instrument and disconnect it from AC line power and all test equipment before removing cover.

1. Set the POWER switch to off and disconnect the power cord from the unit.
2. Remove the six screws on the sides of the top enclosure half and lift the cover off.
3. The calibration cover will now be seen.
4. Remove the calibration cover by taking out the six screws on the top of the cover (see page 2-5). Also, remove the two screws in the center of the rear panel of the instrument located near the top. Lift the cover off.
5. If an Input Card must be removed to make room for the new sensor input card, disconnect the wiring harness mating connector by lifting the locking tab on the Input Card connector and gently pulling on the body of the wiring harness mating connector. Lift the card straight up to remove.
6. Plug the new 9215 Input Card into the A Input Card Slot or the B Input Card Slot with the component side to the left of the unit as viewed from the front.
7. Connect the wiring harness mating connector to the 9215 making sure that the wiring harness locking tab is seated over the extended edge of the wiring harness mating connector. Verify that the wiring harness is in place correctly by noting that the "A" or "B" on the harness mating connector is facing up (*if it is not, review the harness installation again*).
8. Thread the wiring harness along the rear edge of the unit and make sure that the harness is not binding or being pinched in any way.
9. Remove one of the plates marked J11 or J9 on the rear panel by popping it off with a screw driver. Be sure to remove the holding clips that have fallen into the instrument. (*J11 is preferred. J9 is reserved for the scanner card.*)
10. Position the 9215 connector plate in the opening and secure it in place with the screws provided.
11. Replace the calibration cover and the top enclosure half.



# **THE MODEL DRC-91CA TEMPERATURE CONTROLLER INPUT/OPTION CARDS**

## **Sensor Connections**

The 9215 connector plate supplies two independent dual isolated BNC connectors for the sensor connections. A four lead measurement is used to minimize the effect of series resistance on the capacitance measurement. Since the capacitance sensor is non-polarized, one pair should be used for the current connections and the other pair for the voltage connections. The pin contact of the connector is + and the socket -.

## **Selection Of The Sign Of The Temperature Coefficient**

The temperature coefficient of some Capacitance Sensors can be positive or negative depending on the temperature range. The 9215 Card produces a voltage proportional to the Capacitance which is sent to the control circuitry of the unit to be compared to a user selected setpoint. For control to operate properly, the sign of the voltage must reflect the temperature coefficient of the sensor. It is necessary for the user to determine which range the sensor is in and to inform the controller of the sign of the temperature coefficient. This is accomplished by the DRC-93CA by a sequence of key strokes from its front panel or for the DRC-91CA, use the switches on the rear panel. Also, the Sign of the temperature coefficient can be entered via the computer interface using the A or B command.



### **Selection of Temperature Coefficient Sign on the DRC-91CA**









The sign to be used on the temperature coefficient of the capacitance is selected using switch 1 of the appropriate SENSOR ID located on the rear panel of the DRC-91CA.

When switch 1 is closed, the temperature coefficient is positive. When switch 1 is open, the temperature coefficient is negative.

### **Selection of Temperature Coefficient Sign on the DRC-93CA**

When a 9215 Capacitance Input Card is installed, pressing the SENSOR key will display, for the appropriate channel, either  $\pm 15-15$  or  $\pm 15-50$ ; the -15 for the 9215-15 configuration or -50 for the 9215-150 configuration. The ( $\pm$ ) sign indicates whether the temperature coefficient is positive or negative. The plus (+) means that the temperature coefficient is positive. The minus (-) means that the temperature coefficient is negative.

Select the temperature coefficient sign from the front panel by using a combination of the SENSOR key,  key and the  key and  key as follows:

1. Press and hold the SENSOR key.
2. While holding down the SENSOR key, press the  key. You may now let up on the SENSOR key. Do not release the  key.
3. To change the sign if in the upper display press the  key while still holding down the  key. Similarly, to change the sign if in the lower display hit the  key while still holding down the  key.
4. Now let up on the  key or  key and then the  key.

You should press the SENSOR key to make sure that the sign is now correct.

### **Selection of the Sign of the Temperature Coefficient via the Computer Interface**

To select the sign of the temperature coefficient via the IEEE interface, check the A and B commands in Section 4.

# THE MODEL DRC-91CA TEMPERATURE CONTROLLER INPUT/OPTION CARDS

## Principle of Operation

The 9215-15 configuration provides a charging current switched at a frequency of 5 kilohertz. The frequency is precisely controlled by a crystal oscillator. The operation of the 9215-150 is identical except that the frequency is 1 kilohertz. The charging current produces a sawtooth voltage waveform with a peak-to-peak voltage of about 7 volts. Another voltage of precise amplitude is generated which has a duty cycle dependent on the charging time of the capacitor. This waveform is averaged and filtered to produce a positive DC voltage proportional to the capacitance. This DC voltage is sent to a 16 bit A/D converter on the card. The A/D converter has a resolution of 50 microvolts and a full scale input voltage of 3.0000 volts. With the 9215-15 Configuration, the 3.0000 volts corresponds to a capacitance of 30 nanofarads; and on the 9215-150 configuration to 150 nanofarads. The digitized value is converted to a serial data string and transferred to the main microprocessor using optical isolation.

A relay on the Card configures the sensor voltage as negative or positive based on the temperature coefficient sign selected by the user. That voltage is buffered and transferred to the rear panel MONITORS connector for external monitoring as well as to the main board control circuitry.

## Calibration

The 9215 was calibrated to specification prior to shipment. The card meets specification for operation either in the 9215-15 or 9215-150 configuration by simply pressing the switches located on the card. This Section provides information to permit recalibration if needed.

### NOTE

*Calibration for zero capacitance may be required to meet accuracy specifications if your sensor lead capacitance or stray capacitance is excessive.*

The following equipment is used to calibrate the 9215 Capacitance Input Card:

- **Digital Voltmeter/Multimeter (DVM)** 4½ digit resolution or better.
- **Precision Standard Capacitors** 10 nanofarad and 100 nanofarad with tolerance of  $\pm 0.1\%$  or better.
- **Precision Voltage Source** capable of supplying a voltage with an accuracy and resolution of 100 microvolts out of 10 volts or better.

The unit should be allowed a one hour warm-up time to achieve rated specifications. To begin, remove the three screws on each side of the enclosure. Lift the top enclosure half off. The procedure is divided into three parts as follows.

1. Calibration of the A/D Converter.
2. Zero calibration.
3. Span Calibration.

The zero and span calibration is done with the instrument and system wiring configured as it will be used. This will provide optimum accuracy because lead and stray capacitance will be taken into account.

# **THE MODEL DRC-91CA TEMPERATURE CONTROLLER INPUT/OPTION CARDS**

---

## ***A/D Calibration***

1. Locate DIP switch package S1A - Switch 2. Under normal operation this switch is CLOSED(1). Change this switch to the OPEN(0) position.
2. Connect the DVM plus lead to the +V Buffered Sensor Output Signal pin for the appropriate input card and the minus lead to the -V pin on the MONITORS connector. Connect the precision voltage source across the E (+V) and D (-V) pins of the five pin input connector for the input corresponding to the capacitance card.
3. Set the voltage standard to 1.5000 volts.
4. Verify that the display indicates the capacitance input card.
5. Adjust the trimpot marked **A/D (R11)** until the display reads 15.000nF for the 9215-15 or 75.00nF for the 9215-150. Check linearity by inputting 2.0000 and 1.0000 volts and verify that the unit displays 20.000 and 10.000nF within  $\pm 0.001$ nF for the 9215-15 or 100.0 and 50.0nF within  $\pm 0.01$ nF for the 9215-150.
6. Return S1A - Switch 2 to the CLOSED(1) position.

## ***Zero Calibration***

1. Be sure that the leads are in the configuration which will be used in your system. Detach the capacitance sensor.
2. Verify that the display indicates the capacitance input card.
3. Adjust the trimpot marked **ZERO (R28)** so that the display reads 0.000 on the 9215-15 or 0.00 on the 9215-150.

## ***Span Calibration***

1. Be sure that the leads are in the configuration which will be used in your system. Attach the standard capacitor in place of the capacitance sensor.
2. Verify that the display indicates the capacitance input card.
3. Adjust the trimpot marked **SPAN (R24)** so that the display reads the value of the standard capacitor.
4. It will be necessary to recheck the zero after adjusting the span and vice versa until both zero and span values are correct. This may require 3 or 4 repetitions.

# THE MODEL DRC-91CA TEMPERATURE CONTROLLER INPUT/OPTION CARDS

## 9305 THERMOCOUPLE INPUT CARD

### Description

The Model 9305 Thermocouple Input Card allows either Input A or Input B (or both) to accommodate thermocouple sensors. Chromel vs. Gold-0.03 at.% Fe, Chromel vs. Gold-0.07 at.% Fe, E, K, and T thermocouples are supported with internal curves that enable the controllers to operate in temperature units C, F and K, as well as voltage in millivolts.

The 9305 utilizes a secondary temperature sensor to monitor the Reference Junction (room) temperature and provide curve compensation. The Reference Junction Compensation can be disabled so the 9305 can be used with external compensation techniques.

An Offset Adjustment is provided adjacent to the terminal block to compensate for thermocouple variations and system irregularities.

### Specifications

<b>Input Voltage Range</b>	Room Temperature Compensated : -10 to +10 millivolts. Uncompensated: -15 to +15 millivolts.
<b>Temperature Range</b>	Depends on Thermocouple type. See table below.
<b>Thermocouple-EMF Tables</b>	Curve tables are stored in the controller and accessed through normal curve selection. The curves are normalized to zero degree Celsius.
<b>Input Resistance</b>	Greater than $10^9$ ohms
<b>Terminal Block and Room Temperature Compensation</b>	A secondary sensor is installed in the rear panel mounted Terminal Block to measure the Reference Junction Temperature. Compensation can be enabled or disabled.
<b>Offset Adjustment</b>	One-point hardware adjustment built into the Terminal Block.
<b>Electronic Resolution</b>	1 $\mu$ V
<b>Electronic Accuracy</b>	$\pm 3 \mu$ V for -10 and +10 millivolts, $\pm 5 \mu$ V up to the -15 and +15 millivolt full scales.
<b>Overall Accuracy</b>	Depends on conformity of the thermocouple to its standard curve and system configuration.
<b>Controllability</b>	Typically $\pm 0.2$ K in a properly designed system.
<b>Display Resolution</b>	5 digits. Compensated and uncompensated voltage in millivolts from 0.000 to $\pm 15.000$ or temperature in Celsius, Fahrenheit and Kelvin.
<b>Temperature Control Signal</b>	<i>Note: When displaying millivolts, the unit V is shown.</i> Card processes an analog voltage output signal 200 times the thermocouple voltage. The instrument generates setpoint voltage based on the voltage or temperature entered by the user. If compensation is enabled, the setpoint voltage is modified to reflect the compensation required. Real-time analog comparison of these two voltages provides the required control error signal.

### Thermocouple Temperature Ranges

Thermocouple Type	Compensated	Uncompensated
Chromel vs. Au 0.03 at % Fe	4-325K	4-325K
Chromel vs. Au 0.07 at % Fe	1.4-325K	1.4-325K
E	3-425K	3-475K
K	3-525K	3-575K
T	3-485K	3-575K

# THE MODEL DRC-91CA TEMPERATURE CONTROLLER INPUT/OPTION CARDS

## Installation

The 9305 can be installed in a DRC-93CA as either Input A or Input B. The 9305 is installed prior to shipment if ordered with a controller. If only one card is ordered and its input is not specified when ordered, it is installed in Input A.

<b>WARNING</b>	<b>To prevent shock hazard, turn off the instrument and disconnect it from AC line power and all test equipment before removing cover.</b>
----------------	--

1. Set the POWER switch to off and disconnect the power cord from the unit.
2. Remove the six screws on the sides of the top enclosure half and lift the cover off.
3. The calibration cover will now be seen.
4. Remove the calibration cover by taking out the four screws on the top of the cover. Also, remove the two screws in the center of the rear panel of the instrument located near the top. Lift the cover off.
5. If an Input Card must be removed to make room for the new sensor input card, disconnect the wiring harness mating connector by lifting the locking tab on the input card connector and gently pulling on the body of the wiring harness mating connector.
6. Remove one of the plates marked J9 (*for input A*) or J11 (*for input B*) on the rear panel by popping it off with a screw driver. Be sure to remove the holding clips that have fallen into the instrument. Attach the Thermocouple Terminal Block into J9 or J11 with the wires facing the input card. If the JF mating connector on the main board interferes with installation of the terminal block, remove it by lifting the locking tab and gently pulling the body of the connector. Be sure to lock the JF mating connector securely in place after this step is complete.
7. Connect the wiring harness from the terminal block to the (bottom) P3 connector on the 9305 card. Also, connect the J1 (Input A) or J2 (Input B) wiring harness mating connector to the (top) P2 connector on the 9305 card. Make sure that the wiring harness locking tab is seated over the extended edge of the wiring harness mating connector.
8. Plug the 9305 into the appropriate input card slot with the component side facing to the left of the unit as viewed from the front. Make sure the card is thoroughly seated. Verify that the wiring harness is in place correctly by noting that the "A" or "B" on the harness connector is facing up (if it is not, review the harness installation again).
9. Replace the calibration cover and the top enclosure half.

# **THE MODEL DRC-91CA TEMPERATURE CONTROLLER INPUT/OPTION CARDS**

---

## **Sensor Attachment**

Thermocouple leads are attached to the terminal block by aluminum screws. Be sure to tighten the terminal screws carefully. Loose connections will result in unstable readings and control. The leads must be connected with the proper polarity or the 9305 will not operate properly. The positive terminal of the terminal block is marked with a plus sign and should correspond with the positive thermoelement listed for each type of thermocouple below.

## **Types Of Thermocouples**

### **Gold-Chromel Thermocouples**

The Gold Chromel thermocouple consists of a Gold(Au)-0.03 or 0.07 at.% Iron(Fe) alloy as the negative thermoelement and a Ni-Cr alloy (*Chromel*) as the positive thermoelement (*KP*). This type of thermocouple can be used at very low temperatures, even below 10 K.

### **Type E Thermocouples**

The ASTM (*American Society for Testing and Materials*) designation type E indicates a thermocouple pair consisting of a Ni-Cr alloy (*Chromel*) as the positive thermoelement (*EP*) and a Cu-Ni alloy (*Constantan*) as the negative thermoelement (*EN*). This thermocouple has the highest sensitivity of the three ASTM standard thermocouple types typically used for low temperature applications, types E, K, and T. The E thermocouple is the best choice for temperatures down to about 40 K. It is recommended for use in oxidizing environments, or in sulphurous or reducing atmospheres. It should not be used in environments that promote corrosion.

### **Type K Thermocouples**

The ASTM designation type K indicates a thermocouple pair consisting of a Ni-Cr alloy (*Chromel*) as the positive thermoelement (*KP*) and a Cu-Al alloy (*Alumel*) as the negative thermoelement (*KN*). It should not be used in sulphurous or reducing atmospheres, or in environments that promote corrosion.

### **Type T Thermocouples**

The ASTM designation type T indicates a thermocouple pair consisting of Cu (*Copper*) as the positive thermoelement (*TP*) and a Cu-Ni alloy (*Constantan*) as the negative thermoelement (*TN*). This type of thermocouple may be used in vacuum as well as oxidizing or reducing environments down to about 90 K. At temperatures below 80 K the thermoelectric properties of the positive thermoelement (*TP*) are very dependent on the impurity of iron.

# **THE MODEL DRC-91CA TEMPERATURE CONTROLLER INPUT/OPTION CARDS**

---

## **Operation**

The 9305 Thermocouple Input Card has the capability of interfacing 5 different thermocouple types to the LakeShore DRC-91CA/DRC-93CA Temperature Controller over their respective temperature ranges.

The thermocouple voltage is amplified by 100 by a circuit which is attached to the terminal block. The thermocouple voltage is further amplified by a factor of 2 (tunable) by the Control Amplifier on the 9305 Thermocouple Input Card.

The amplified signal is sent to the main board analog control circuitry and can be accessed from the Buffered Output line of the J3 Monitor Connector on the controller's back panel. In addition, the amplified thermocouple voltage is applied to a 15 bit A/D converter on the Thermocouple Input Card so that digitized thermocouple voltage can be sent to the main board microprocessor. The Thermocouple A/D converter has an auto-zero function which means that the only calibration required is for the relative gain.

A secondary diode temperature sensor is attached to the terminal block to monitor the reference junction temperature needed for Reference Junction Compensation. A constant current source on the 9305 Card is applied to the secondary sensor. A 15 bit A/D converter on the 9305 Card digitizes the secondary sensor voltage and sends the data to the main board microprocessor. The microprocessor on the main board of the controller calculates the reference junction temperature. The reference junction temperature is used in compensation to account for the difference between room temperature and the normalization temperature of the curves, zero degrees celsius.

An offset adjustment is provided adjacent to the terminal block. This adjustment will zero out small voltage offsets that result from sensor lead attachment and differences from the internal curve.

## **Display Operation**

Digitized thermocouple and secondary sensor voltages on the 9305 card are sent to the main board of the controller. The secondary sensor temperature is computed from its voltage and a thermocouple voltage corresponding to the secondary sensor temperature is calculated. If correction is selected, the compensation value is added to the thermocouple voltage. Corrected voltage in millivolts is then used as a display value or converted to celsius degrees, Fahrenheit degrees, or kelvin for display.

## **Control Operation**

Control operation begins when the operator enters a setpoint voltage in millivolts. If the setpoint is in temperature, the main board computes an equivalent voltage using the built-in thermocouple table. The main board microprocessor then checks to see if Reference Junction Compensation is enabled.

If the Reference Junction Compensation is disabled, a signal which is 200 times the digital value of setpoint voltage is applied to the setpoint D/A to obtain the setpoint voltage for control.

If the Reference Junction Compensation is enabled, a voltage corresponding to the terminal block temperature is subtracted from the setpoint voltage. A signal which is 200 times the digital value as calculated above is applied to the setpoint D/A to obtain the setpoint voltage for control.

The analog control hardware compares the setpoint voltage from the setpoint D/A converter and the amplified thermocouple voltage to obtain an error signal. The error signal is minimized through the PID control circuitry.

# THE MODEL DRC-91CA TEMPERATURE CONTROLLER INPUT/OPTION CARDS

## Operating Instructions

### Thermocouple Curve Selection

Thermocouple Tables are chosen by selecting one of the curve numbers given in the table below. The instrument detects the presence of the Thermocouple Input Card and then selects the proper Thermocouple Table rather than the Standard Diode or Resistance curve listed in this manual previously. Refer to the curve selection portion of this manual.

Thermocouple Type	Standard Curve #
Chromel vs. Au-0.07 at.% Fe	00
Chromel vs. Au-0.03 at.% Fe	01
E	02
K	03
T	04





### Selection of Reference Junction Compensation on the DRC-91CA

Reference Junction Compensation is selected using switch 3 of the SENSOR ID. When switch 3 is closed (1), the Reference Junction Compensated value of the thermocouple voltage is displayed. When switch 3 is open (0), the actual (*measured*) thermocouple voltage or uncompensated temperature is displayed. With the 9305 selected as the display sensor, hold the LOCAL key to show the card type and curve number. If compensation is active, the display will show +9305 and if it is inactive, the display will show -9305.

### Selection of Reference Junction Compensation on the DRC-93CA

Pressing the SENSOR key will display either +9305 or -9305. +9305 means that the thermocouple voltage is corrected for the Terminal Block temperature. The -9305 means that the thermocouple voltage is being displayed with no compensation.

To determine whether Reference Junction Compensation is used: a

1. Press and hold the SENSOR key.
2. While holding the SENSOR key, press the  key. You may now release the SENSOR key. Do not release the  key.
3. To change the sign if in the upper Display press the ▲▲ key while still holding down the  key. Similarly, to change the sign if in the lower Display press the ▼▼ key while still holding down the  key.
4. Release the ▲▲ key or ▼▼ key and then the  key.

You should press the SENSOR key to verify that the sign is as desired.

### Selection of Reference Junction Compensation via the Computer Interface

To select or prevent Reference Junction Compensation via the IEEE interface, use the A and B commands described in Section 4. The Reference Junction Compensation bit may be listed as switch 3 or the Thermal Correction bit (*used on the 9318C card*). Turning on (1) that position turns on the compensation.



# THE MODEL DRC-91CA TEMPERATURE CONTROLLER INPUT/OPTION CARDS

## Rear Panel Offset Adjustment

When a new or different thermocouple is attached to the instrument, it is desirable to permit the addition of an offset to compensate for discrepancies in the thermocouple material, leads and connections. An offset adjustment trimpot is provided next to the terminal block on the back panel to allow quick calibration of the thermocouple without removal of the instrument cover. The procedure is as follows.

1. Place the thermocouple in a reference bath of known temperature (liquid nitrogen, ice, etc.). Allow the system to stabilize to the Reference Temperature.
2. With the front panel of the instrument, select the thermocouple input and the desired temperature units.
- 3a. On the DRC-91CA enable Reference Junction Compensation by closing (1) switch 3 of the appropriate SENSOR ID on the rear panel. Hold the LOCAL key and verify the display as +9305.
- 3b. On the DRC-93CA enable Reference Junction Compensation by using the SENSOR, , and ▲▲ or ▼▼ keys. The display should show +9305 when the SENSOR key is pressed. (See *previous page*.)
4. Adjust the offset adjustment trimpot so that the display reads the reference temperature.

### NOTE

*The offset adjustment compensates for the thermocouple used in the calibration. If another thermocouple is attached, or the thermocouple has aged, or the configuration of the system is changed, then the offset adjustment must be repeated.*

## Curve Data Format

The 9305 Thermocouple Input Card will operate with a user defined curve as well as the internal curves. Temperature is calculated by linear interpolation between curve points.

The card is hardware limited to reading input between -15 millivolts and +15 millivolts. All curves should be limited in temperature so not to exceed these voltage values. If Reference Junction Compensation is desired, the thermocouple curve must be normalized to zero degrees celsius. Compensation also limits the practical range of the card by approximately the room temperature voltage of the thermocouple used.

The controllers are designed to operate on sensor curve data in the range of 0.00000 to 3.00000 volts so thermocouple voltage must be converted to this range before it is entered into a curve table. To obtain the proper table value from a thermocouple voltage, it must be summed with 15 millivolts to make it positive and multiplied by one hundred to shift resolution.

$$V_{\text{TABLE}}(\text{V}) = 100 * (V_{\text{THERMOCOUPLE}}(\text{mV}) + 15(\text{mV}))$$

A -15.0000 millivolt thermocouple voltage will result in a 0.00000 volt table value and +15.0000 millivolts will result in 3.00000 volts.

Once the thermocouple curve has been converted, carefully read the appropriate sections of this manual to enter the data into a controller.

# THE MODEL DRC-91CA TEMPERATURE CONTROLLER INPUT/OPTION CARDS

## Calibration

The design of the 9305 Thermocouple Input Card is such that calibration should not be required more often than every six to twelve months in order to keep the card within its accuracy specification. However, if calibration is required, the following equipment is needed:

**Digital Voltmeter (DVM)**      5 1/2 digit resolution or better.  
**Precision Voltage Standard**    capable of a 10 millivolt signal to within  $\pm 1$  microvolt.

The accuracy of the calibration depends on the accuracy of the Digital Voltmeter (DVM) and the voltage standards used. Since very often these values will not be available to the user of this instrument, LakeShore Cryotronics, Inc. offers a calibration service. Contact a factory representative for information concerning calibration.

### NOTE

*Additional instructions required when calibrating the setpoint D/A converter with the 9305 card is to make sure that the Reference Junction Compensation is turned off.*

The controller should be allowed a one hour warm-up time to achieve rated specifications.

1. Remove the top enclosure half. See page 5-24.
2. Configure the controller so the card to be calibrated is the CONTROL input.
3. Locate the DIP switch S1 on the 9305 Input Card. Open (0) S1.1 for calibration. This forces the 9305 to update secondary sensor information every conversion cycle. Under normal operation (S1.1 closed (1)) secondary sensor information is updated once every 25 cycles.
4. Locate the secondary sensor current sensing resistor terminals (I+ and I-), the secondary current source adjustment ( $10\mu\text{A}$ ) (R16), the control amplifier span adjustment (CNT V) (R2), and the A/D converter span adjustment (A/D) (R22) on the calibration cover for the 9305 Card.
5. Locate the rear panel offset adjustment on the terminal block.
6. Locate the test points TP24 (CNT V) and TP1 (GND(2s)) of the calibration card.
7. Avoid using clip on leads during calibration because they do not make good electrical connections. Attach test equipment lead wires with the terminal screws on the thermocouple block.

The calibration procedure is divided into three parts.

1. Calibration of the secondary sensor current source.
2. Calibration of the control signal amplifier and rear panel offset adjustment.
3. Calibration of the thermocouple and secondary sensor A/D converters on the 9305 thermocouple card.

# THE MODEL DRC-91CA TEMPERATURE CONTROLLER INPUT/OPTION CARDS

---

## **Secondary Sensor Current Source Calibration**

1. Connect the DVM plus lead to terminal I+ (TPI) and the DVM minus lead to the I- (TP2) terminal. Both test points are located on the 9305 sensor input card.
2. Adjust the trimpot labelled 10 $\mu$ A (R16) so that the DVM reads 1.000 volt  $\pm$ 0.001 volt.

## **Control Amplifier and Rear Panel Offset Adjustment Calibration**

1. With the front panel of the instrument, select the thermocouple input and place in the V (voltage) units.
- 2a. On the DRC-91CA, disable Reference Junction Compensation by opening (0) switch 3 of the appropriate SENSOR ID on the rear panel.
- 2b. On the DRC-93CA, disable Reference Junction Compensation by using the SENSOR, , and  $\blacktriangle\blacktriangle$  or  $\blacktriangledown\blacktriangledown$  keys. The display should show -9305 when the SENSOR key is pressed.
3. Connect the DVM plus and minus leads to the TP24 (CNT V) and TP1 (GND(2s)) found on the calibration card of the controller.
4. Apply a zero signal to the +V and -V Thermocouple Input terminals by shorting across the terminal block with a short jumper wire. Allow the terminal block temperature to settle for five minutes.
5. Adjust the rear panel offset adjustment on the terminal block until the output on the DVM is 0.0000 volt. Be sure to remove the jumper wire after this step.
6. Apply a +10 millivolt signal to the +V and -V Thermocouple input terminals on the terminal block and allow the temperature to settle.
7. The DVM should read about -2 volts. Adjust the input card trimpot labeled CNT V (R2) (Control Voltage Span) until the output on the DVM is -2.000 volts  $\pm$ 0.0001 volt.

## **Thermocouple and Secondary Sensor A/D Calibration**

The thermocouple and secondary sensor A/D converters have an auto-zero function which means that the only calibration required is for the relative gain (span). The procedure is as follows.

1. Make sure the instrument is setup.
2. Apply a +10 millivolt signal to the +V and -V thermocouple input terminals on the terminal block.
3. The display should read about 10 millivolts. Adjust the trimpot labeled A/D (R22) (Thermocouple A/D Span) so that the voltage read on the display is 10.000 millivolts.
4. This test is to verify that the A/D converter is symmetrical. Apply a -10 millivolt signal to the +V and -V thermocouple input terminals. The DVM should read +2.0000  $\pm$ 0.0006 volt. The display should read -10.000  $\pm$ 0.003. If it does not meet these specifications, recheck the previous steps in the calibration. If this does not correct the problem, the unit should be returned to the factory for calibration.

# **THE MODEL DRC-91CA TEMPERATURE CONTROLLER INPUT/OPTION CARDS**

---

## **Reference Junction Test**

This test is to verify that the Reference Junction Compensation circuitry is operating properly. If this test does not produce the following results, please consult the factory.

1. Apply a zero volt signal to the +V and -V thermocouple input terminals by shorting across the terminal block with a short jumper wire.
2. Set the controller to display the 9305 card in temperature units.
3. Enable the Reference Junction Compensation. The reading on the display should read room temperature.
4. Disable the Reference Junction Compensation and the display should read zero degrees celsius (*the normalization point of the curves*).

## **Calibration Completion**

1. Close (1) S1.1 to return the 9305 to normal secondary sensor update operation.
2. Remove anything that may be shorting the two halves of the terminal block.
3. Verify that thermal correction is properly selected.
4. Replace the top enclosure half.

## **Option Compatibility**

The special nature of thermocouple sensors, and their connections, limits compatibility with Lake Shore options and accessories. Thermocouples must be attached directly to the terminal block. The 8229 Scanner Input Option and 8085 External Sensor Scanner are not adapted with terminal blocks so they can not be used with the 9305 Thermocouple Card. The 8225 Linearized Analog Output Option will function in temperature units only when a 9305 is installed, giving an output of 10mV/K. The 8000 series Precision Calibration Options are not available from Lake Shore for thermocouple sensors.

# THE MODEL DRC-91CA TEMPERATURE CONTROLLER INPUT/OPTION CARDS

## 8223 RS-232C INTERFACE OPTION

### Description

The 8223 RS-232C Interface is designed to provide an interface with an external RS-232C instrument such as a computer, modem or CRT. The interface operates in a half duplex mode (*it can only transmit and receive information in one direction at a time*) and data transmission is asynchronous (*each character is bracketed by start and stop bits that separate and synchronize the transmission and receipt of data*). The baud rate is switch selectable at 300 or 1200 baud and the interface maintains EIA voltage levels for data transmission.

### Specifications

Timing Format	Asynchronous
Transmission Mode	Half Duplex
Baud Rate	300 or 1200 Bits/sec (Factory set to 300)
Bits per Character	7(excluding start, stop or parity bits)
Parity Enable	Enabled/Disabled (Factory set Enabled)
Parity Select	Odd or Even (Factory set Odd)
Number of Stop Bits	1 or 2 (Factory set to 1)
Data Interface Levels	Transmit or receive using EIA voltage levels (+12V and -5)

### Introduction

The figure below gives a transmission format which shows the data bits framed by the start and stop synchronization bits. The data are transmitted using two voltage levels which represent the two binary states of the digit. A logic 0 (*or SPACE*) is +3 to +12 VDC. A logic 1 (*or MARK*) is -3 to -5 VDC. When data is not being transmitted, the line is held low (*MARK state*). When the transmission device is ready to send data, it takes the line to the high (*SPACE*) state for the time of one bit. This transition is called the start bit. The remaining data is then transmitted. If a parity bit is used, it follows the character. The parity bit is determined by the number of 1 bits in the character.

Number of "1"s in character	Parity Specified	Parity Bit
Odd	Odd	0
Even	Odd	1
Odd	Even	1
Even	Even	0

### Word Structure

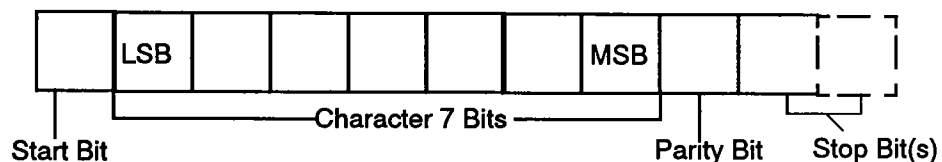

## THE MODEL DRC-91CA TEMPERATURE CONTROLLER INPUT/OPTION CARDS

The Model 8223 RS-232C Interface has a 25-pin D style connector located on the rear panel. Pin Assignments are shown below.

Pin	Description	Signal
1	Protective Ground	AA
2	Transmitted Data	BA
3	Received Data	BB
4	Request To Send	CA
5	Clear To Send	CB
6	Data Set Ready	CC
7	Signal Ground	AB
8	Received Line Signal Detector	CF
20	Data Terminal Ready	CD

The RS-232C signals are used in the following manner:

**Protective Ground (AA)** - conductor is taken to case ground potential and is common with the signal ground (AB).

**Transmitted Data (BA)** - transmits data using the EIA voltage levels (+12V and -5V).

**Received Data (BB)** - accepts data using EIA voltage levels.

**Request to Send (CA)** - indicates to the host computer or terminal that the controller Interface is ready to transmit data. The Interface transmits data on line BA when the "ON" state is maintained on CC, CB and CF, while a low level on these lines inhibits transmission by the Interface.

**Clear to Send (CB)** - indicates to the Interface that data transmission is allowed. Internally pulled up to maintain "ON" state when left disconnected.

**Data Set Ready (CC)** - indicates to the Interface that the host computer or terminal is not in a test mode and that power is ON.

**Signal Ground (AB)** - this line is the common signal connection for the Interface.

**Received Line Signal Detector (CF)** - this line is held positive ("ON") when the Interface is receiving signals from the host computer. When held low ("OFF") the BB line is clamped to inhibit data reception. Internally pulled up to maintain "ON" state when left disconnected.

**Data Terminal Ready (CD)** - asserted by the Interface whenever the DRC-91CA/DRC-93CA/8223 power is "ON" to indicate that the Interface is ready to receive and transmit data.

# THE MODEL DRC-91CA TEMPERATURE CONTROLLER INPUT/OPTION CARDS

## Configuration of Dip Switches

### Selection of Baud Rate

The Model 8223 has a field selectable baud rate using DIP switch package S1 (8 switches) on the Interface card. The baud rate is selected by closing the switch position for the desired baud rate and making sure all other positions are open. The baud rate selection is given in the table below. Only the 300 and 1200 baud rates have been tested and are fully supported.

**Baud Rate Switch S1 Selection Table**

Switch S1								Baud Rate
1	2	3	4	5	6	7	8	
1	0	0	0	0	0	0	0	75
0	1	0	0	0	0	0	0	110
0	0	1	0	0	0	0	0	135
0	0	0	1	0	0	0	0	150
0	0	0	0	1	0	0	0	200
0	0	0	0	0	1	0	0	<b>300</b>
0	0	0	0	0	0	1	0	600
0	0	0	0	0	0	0	1	<b>1200</b>

### Word Structure Selection

The word structure is determined by switch settings for character length, parity and stop bits using DIP switch package S2 on the Interface Card (6 switches). Refer to the table below for settings where "0" is OPEN and "1" is CLOSED.

**Word Structure Switch S2 Selection Table**

Switch S2						Word Structure Choices
1	2	3	4	5	6	
						<b>Stop Bits</b>
0	0	X	X	X	X	Invalid
0	1	X	X	X	X	1 Bit
1	0	X	X	X	X	1½ (not supported)
1	1	X	X	X	X	2 Bits
						<b>Parity Genertn/Chck</b>
X	X	1	X	X	X	Even
X	X	0	X	X	X	Odd
						<b>Parity Enable</b>
X	X	X	1	X	X	Enable
X	X	X	0	X	X	Disable
						<b>Character Length Bits</b>
X	X	X	X	0	0	5 (not supported)
X	X	X	X	0	1	6 (not supported)
X	X	X	X	1	0	7 (supported)
X	X	X	X	1	1	8 (not supported)

**NOTE**

For the not supported settings, the interface will respond, but the card has not been tested with these settings at the factory. X is a don't care setting for that switch.

# THE MODEL DRC-91CA TEMPERATURE CONTROLLER INPUT/OPTION CARDS

## Installation

The 8223 RS-232C Interface is factory installed if ordered with a Temperature Controller or can be field installed at a later date. If field installation is required, use the following procedure.

**WARNING** To prevent shock hazard, turn off the instrument and disconnect it from AC line power and all test equipment before removing cover.

1. Set the POWER switch to off and disconnect the power cord from the unit.
2. Remove the six screws on the sides of the top enclosure half and lift the cover off.
3. The calibration cover will now be seen.
4. Remove the calibration cover by taking out the six screws on the top of the cover. (see page 2-5) Also, remove the two screws in the center of the rear panel of the instrument located near the top. Lift the cover off.
5. Configure the 8223 baud rate and word structure switches.
6. Plug the internal interface cable into the 8223 printed circuit board (PCB) with the locking tab configured properly.
7. Plug the 8223 PCB into Option Slot 2 with the component side to the left of the unit as viewed from the front.
8. Carefully thread the RS-232C internal cable along the inside edge of the rear panel so that it will not interfere with the installation of the calibration cover or top cover.
9. Remove the plastic cover plate from J10 on the rear panel. Position the 25-pin RS-232C Interface connector in the J10 opening on the back panel and secure it in place using the screws provided.
10. Replace the calibration cover and the top enclosure half.



# THE MODEL DRC-91CA TEMPERATURE CONTROLLER INPUT/OPTION CARDS

---

## Operation

The 8223 RS-232C Interface has a 256 character FIFO buffer for input commands. The interface accepts commands, the same as for the IEEE-488 Interface, until it sees the End-of-Line (EOL) sequence. The 8223 requires a carriage return/line feed (CR)(LF) or just line feed (LF) as its input EOL and transmits carriage return/line feed (CR)(LF) as its output EOL. Following the EOL Sequence, the command string is processed.

Operation of the Interface link is initiated by the computer. The computer will transmit either a Program Code or an Output Request to the 8223 Interface. The DRC-91CA/DRC-93CA will respond to the Output Request with the appropriate response or with the response and an error message (*if an error was detected*). The interface responds to Program Code Commands by storing the variables input.

The Programming Commands given in Section 4 input only and do not result in a response from the interface. The Commands T and Z will be accepted and updated even though they have no relevance to the interface (the EOL terminator sequence is always (CF)(LF) and there is no EOI status). The M command can be considered the "OFF LINE" (Local) and "ON LINE" (Remote or Remote with Local Lockout) states. When "OFF LINE" (Local) parameters such as SENSOR ID (as well as Gain, Rate and Reset) are updated from the hardware settings while "ON LINE", these parameters can be updated from the computer only.

The Output Statement commands given in Section 4 will result in the requested data being output immediately following the reception of the EOL sequence. If more than one Output Statement command is given, the last one received will be acknowledged. Programming Codes and Output Statements can be sent in the same command string. For example, the command string:

**S24.5P40I20D25R2**

would result in the Set Point being updated to 24.5, the Gain to 40, the Reset to 20, the Rate to 25 and the Heater Range to  $10^{-3}$ . No Output Statement was given so no response will be output by the interface. The command string:

**S24.5P40I20D25R2W0**

will result in the W0 contents being output by the interface. (Refer to Section 4 for a detailed discussion of the Output Statement commands.)

All commands beginning with W plus the XDT, XDA and XD commands are Output Statement style commands which result in a response from the interface. The balance of the commands are Programming Code style commands which do not result in a response from the interface. Care must be taken with the XC command not to overrun the 256 character buffer of the 8223 interface. As in the IEEE operation, if a hardware problem is detected in modifying one of the memory locations, an ERR01 error will be displayed in the Display and instrument operation will be halted. Consult a factory representative if this error occurs.

## **THE MODEL DRC-91CA TEMPERATURE CONTROLLER INPUT/OPTION CARDS**

---

There are four errors that could be detected by the 8223 interface.

1. **Err10 - Parity Error** - may be caused by signal line transients or incorrectly specified parity.
2. **Err11 - Overrun Error** - caused by the main processor not reading the input character before the next one becomes available. The overrun character(s) are lost.
3. **Err12 - Framing Error** - may be caused by signal line transients or incorrectly specified stop bits or character length.
4. **Err13 - Input Buffer Overrun** - caused by more than 256 characters being input to the FIFO buffer. Any characters received after the 256th character are lost.

Detection of an error does not affect the operation of the interface. The software that interprets the data tries to match the character input to the possible command inputs and processes the command. The error is also transmitted by the interface the next time it is asked for a response. The error is transmitted in addition to the Output Statement data output. For example, if a framing error was detected in a command string transmitted to a DRC-91CA/DRC-93CA as:

**P50W3**

the interface might respond with:

**Err12  
50.,25.,20.,2,047(CR)(LF)**

If the error was detected in the transmission of the "P", the gain change would be ignored; if it was in the "50", one or two numerics may have been generated. If the error was detected in the "W", the interface may not respond, in which case it would need to see another Output Statement command. If the error was in the "3", the interface may or may not have responded with W3 data. It may default to W0. Although errors rarely occur, it is suggested that any commands sent to the DRC-91CA/DRC-93CA be echoed back by sending the appropriate Output Statement command and inputting the stored parameters. Any error that is detected is cleared following the first transmission after the error.

# THE MODEL DRC-91CA TEMPERATURE CONTROLLER INPUT/OPTION CARDS

## Interfacing Examples

### Example 1 HP-86B Computer, Half Duplex Without Handshake.

The HP82939A Serial Interface for the HP-86B is preset at the factory for the following default values:

1. Interface select code = 10
2. Baud rate = 300 Baud
3. Autohandshake = Off
4. Character Length = 7 bits
5. Parity = Odd
6. Stop bits = 1
7. Cable Option = Standard (25 pin socket)

Since the HP default Baud rate, character length, parity and stop bit configuration are the same as those of the 8223 Interface when shipped, none of the switches on the 8223 board need to be changed.

When connecting the HP-86B Serial Interface to the 8223 Interface, a transition cable needs to be made to connect the socket connector of the HP to the socket connector of the 8223 Interface.

The adapter cable that must be made is shown here. The arrows indicate the source and direction of signal flow.

Half Duplex W/O Handshake

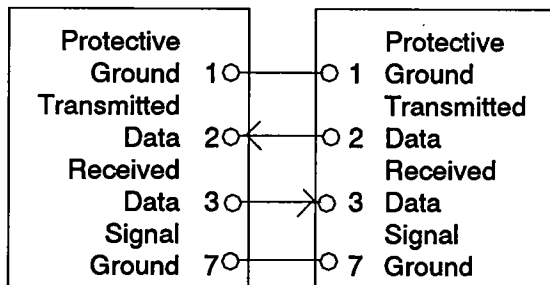

The following program will input a command from the keyboard and output it to the 8223. The program will then input the specified 8223's response, display it and return for another command.

```
10 REM HALF DUPLEX W/O HANDSHAKE
15 REM I/O TEST (RS232 TEST1)
20 DIM A$[256],B$[3000]
25 REM A$ IS OUTPUT, B$ IS INPUT
30 INPUT A$
35
40 OUTPUT 10 ; A$
50 ENTER 10 ; B$
55
60 DISP B$
70 GOTO 30
80 END
```

! MAKE SURE TO GIVE AN  
! OUTPUT STATEMENT COMMAND  
! OUTPUT COMMAND  
! INPUT THE DATA  
! FROM THE CONTROLLER  
! DISPLAY DATA  
! RETURN FOR MORE

# THE MODEL DRC-91CA TEMPERATURE CONTROLLER INPUT/OPTION CARDS

## Example 2. HP-86B Computer, Half Duplex, with Handshake.

The adapter cable for Half Duplex with handshake communications is with an HP-86B Serial Interface is shown here. The arrows indicate the source and direction of signal flow.

### Half Duplex With Handshake

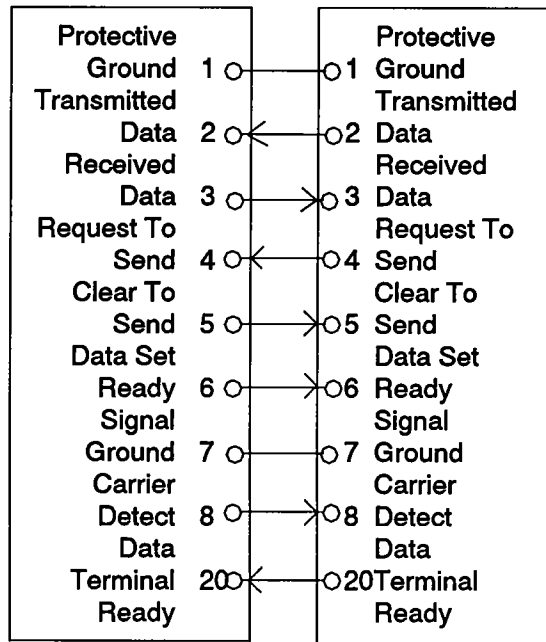

The Auto Handshake capability of the HP-86B Serial Interface must be enabled. The addition of the program line:

```
16 CONTROL 10,2;7
```

```
1 ENABLE DSR,DCD,CTS
```

to the program above enables the HP to receive and transmit in a handshake mode.

# THE MODEL DRC-91CA TEMPERATURE CONTROLLER INPUT/OPTION CARDS

## Example 3 General Serial Interface Interconnection.

The HP-86B Serial Interface Standard cable configuration already takes care of some of the interface interconnection problems to route signals to their proper pins. Given below are more general interconnection configurations for Half Duplex with and without Handshake.

### General Serial Interface Interconnection for Half Duplex with Handshake

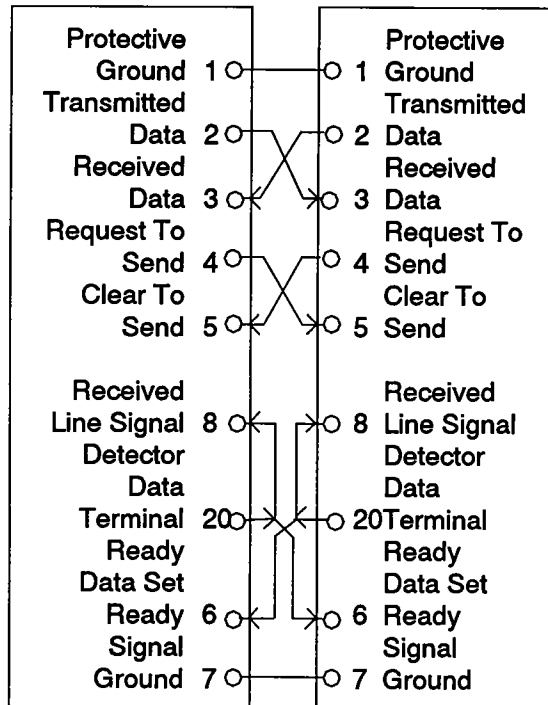

### General Serial Interface Interconnection for Half Duplex without Handshake

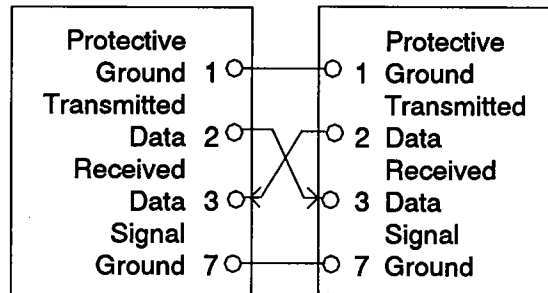

**NOTE**

*It may be necessary to jumper pins 5, 6, 8 and 20 to disable the handshake functions of the Host. This is not required for the 8223 Interface.*

# THE MODEL DRC-91CA TEMPERATURE CONTROLLER INPUT/OPTION CARDS

**Example 4** For an IBM use the following program in Quick Basic

## General Serial Interface Interconnection for Half Duplex without Handshake

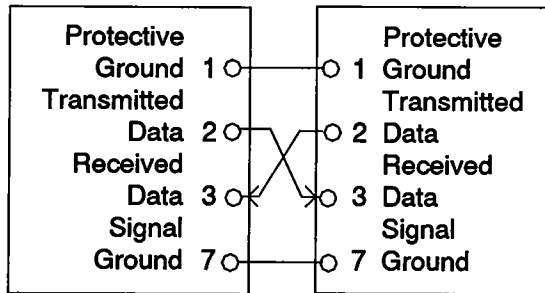

**NOTE** It may be necessary to jumper pins 5, 6, 8 and 20 to disable the handshake functions of the Host. This is not required for the 8223 Interface.

### Test Program for RS232 Communications in Quick Basic 4.0

```

OPEN "com1,o,7,1,RS" FOR RANDOM AS #1 LEN = 256 'SERIAL PORT INITIALIZATION
L1:INPUT "ENTER COMMAND"; A$                'GET COMMAND FROM USER
PRINT #1, A$ + CHR$(13) + CHR$(10);        'SEND COMMAND AND CR
                                           'LF TO INSTRUMENT
LINE INPUT #1, B$                          'GET RESPONSE FROM THE
                                           'INSTRUMENT
PRINT B$                                    'PRINT INSTRUMENT RESPONSE
GOTO L1                                     'JUMP BACK FOR NEXT
                                           'COMMAND
    
```

### Test Program for RS232 Communications in BASICA

```

10 OPEN "com1,o,7,1,RS" AS #1                'SERIAL PORT INITIALIZATION
20 INPUT "ENTER COMMAND";A$                'GET COMMAND FROM USER
30 PRINT #1, A$                             'SEND COMMAND TO
                                           'INSTRUMENT
40 LINE INPUT #1, B$                        'GET INSTRUMENT RESPONSE
50 PRINT B$                                 'PRINT INSTRUMENT RESPONSE
60 GOTO 20                                  'JUMP BACK FOR NEXT
                                           'COMMAND
    
```

**NOTE** For these simple programs, a query must be included as the last part of a command string or the program will stop when it tries to read the instrument response.

# THE MODEL DRC-91CA TEMPERATURE CONTROLLER INPUT/OPTION CARDS

## 8225 ANALOG OUTPUT OPTION

### Description

The 8225 Analog Output option is designed to be installed in a DRC-91CA/DRC-93CA and provide an analog output proportional to the kelvin temperature of the display or control sensor for the purpose of recording, either with a strip chart recorder or other similar device, the sensor temperature.

The analog output is present on the J3 MONITORS connector on the unit's back panel with pin C being the V+ output and pin D being the V- output. A jumper on the 8225 selects display or control sensor data.

### Specifications

<b>Output Range</b>	0.000 to +10.000 V
<b>Output Resolution</b>	1mV out of 10V
<b>Output Resistance</b>	Less than 10 $\Omega$
<b>Output Equivalence</b>	
<b>Temperature (for all Input Cards):</b>	
- Output: 0.000 to 9.999 V for display of 0 to 999.9 K	
- Sensitivity: 10 mV/K	
<b>Voltage (for 9210 and 9220)</b>	
- Output: 0.0000 to 6.554 V for display 0.0000-6.5535 V ( $\pm 15\text{mV uncomp. } \pm 10\text{mV comp. for 9305}$ )	
- Sensitivity: 1 V/V.	
<b>Resistance (9220-P2, -P3 and -R1)*</b>	
<b>-P2:</b>	
- Output - 0.000 to 3.000 V for display 0.00 - 300.00	
- Sensitivity - 10 mV/ohm	
<b>-P3:</b>	
- Output - 0.000 to 3.000 V for display 0.0 - 3000.0	
- Sensitivity - 1 mV/ohm	
<b>-R1</b>	
- Output - 0.000 to 10.000 V for display 0.000 - 99.999	
- Sensitivity - 100 mV/ohm	

\* The resistance of the 9317C and 9318C Input Cards is not output by the 8225 because of the number of orders of magnitude the display can cover. The analog output of temperature displayed by these Input Cards is available if a Precision Option is present for the sensor.

# THE MODEL DRC-91CA TEMPERATURE CONTROLLER INPUT/OPTION CARDS

## Installation

The 8225 Analog Output is factory installed if ordered with a DRC-93CA or can be field installed at a later date. If field installation is required, use the following procedure.

**WARNING** To prevent shock hazard, turn off the instrument and disconnect it from AC line power and all test equipment before removing cover.

1. Set the POWER switch to off and disconnect the power cord from the unit.
2. Remove the six screws on the sides of the top enclosure half and lift the cover off.
3. The calibration cover will now be seen.
4. Remove the calibration cover by taking out the six screws on the top of the cover. (see page 2-5) Also, remove the two screws in the center of the rear panel of the instrument located near the top. Lift the cover off.
5. Configure the red jumper on the 8225 printed circuit board for SAMPLE (Display Sensor) or CONTROL (Control Sensor).
6. Plug the 8225 printed circuit board into Option Slot 1 or 2 with the component side to the left of the unit as viewed from the front.
7. Thread the two black and white wires from the 8225 along the inside edge of the rear panel and solder the white wire to MONITOR connector J3 - Pin C and black wire to Pin D.
8. Replace the calibration cover and the top enclosure half.

## Operation

The output resolution and equivalence is given in the Specifications. For a temperature display of 100.00K, the 8225 will output 1.000V. The output is rounded to the equivalent unit for the 1mV output. A display of 23.42K will result in an output of 0.234V and a display of 23.47K will result in an output of 0.235V.



# THE MODEL DRC-91CA TEMPERATURE CONTROLLER INPUT/OPTION CARDS

---

## Calibration

The Model 8225 has been calibrated to specification prior to shipment. If recalibration is needed, use the following procedure. The following equipment is used to calibrate the 8225 Analog Output:

- **Digital Voltmeter/Multimeter (DVM)** 4½ digit resolution or better.
- **Precision Standard Resistor** to simulate the input sensor or a Precision Voltage Source with an output resolution of 100uV out of 3V or better.

The unit should be allowed one hour to warm up to achieve rated specifications. Use the following procedure to calibrate the 8225 Analog Output:

1. Remove the top enclosure half (*see previous page*).
2. Connect the DVM plus lead to the J3 MONITORS connector pin C and the minus lead to pin D.
3. With the load resistors, or the voltage standard, to simulate the input sensor, go to a low temperature and adjust the trimpot labeled Z (R2) (for Zero) on the calibration cover until the voltmeter reading corresponds to 10mV/K. Go to a high temperature and adjust the trimpot labeled S (for Span) (R1).
4. Repeat procedure in step 3 until there is no further Zero or Span adjustment required.
5. Replace the top enclosure half.

# THE MODEL DRC-91CA TEMPERATURE CONTROLLER INPUT/OPTION CARDS

## 8229 Scanner Conversion

### Description

The 8229 Scanner Conversion provides four additional channels of sensor input to Input A. The 8229 inputs are designated A1 through A4 and their selection is identified in the display window at the left of the display. With the 8229 installed, the DRC-91CA/DRC-93CA is expanded from the standard two sensor inputs to handle six input sensors.

The 8229 A1 through A4 channels can be selected directly (using the SENSOR key [A sensor key for the DRC-91CA]) or included in the SCAN sequence. An independent Dwell time (0 to 99 seconds) can be assigned to each of the additional inputs.

The A1 through A4 channels of the Model 8229 Scanner are accessed through a 24-pin "D" style connector located in the J9 Option Port on the rear panel.

### Specifications

<b>Number of Channels</b>	4 (in addition to the existing Inputs, A and B), designated A1 through A4.
<b>Contact Configuration</b>	4 pole (2 current poles make-before-break, 2 voltage poles break-before-make).
<b>Maximum Input Voltage</b>	32 volts DC or peak AC.
<b>Maximum Current</b>	10 milliamperes.
<b>Thermal Offset</b>	Less than 3 microvolts per contact on break-before-make poles, less than 50 microvolts on others.
<b>Contact Resistance</b>	Less than 1 $\Omega$ .
<b>Open Channel Isolation</b>	>10 <sup>10</sup> $\Omega$
<b>Input/Output</b>	24-pin "D" style connector, mate supplied.
<b>Channel Selection</b>	Front panel SENSOR A key increments A0, A1, A2, A3, A4, A0, etc. each time it is pressed or automatically in the SCAN mode. All front panel operations can be duplicated over the remote interfaces.
<b>Switch Contact Life</b>	>10 <sup>8</sup> operations at rated load.
<b>Configuration</b>	Channels A0 through A4 are configured as Remote Position A00 through A04 with respect to Sensor. Curve selection with 8229 present.
<b>Channel Selected Data</b>	Channel selected present in BCD form on J9 connector.

# THE MODEL DRC-91CA TEMPERATURE CONTROLLER INPUT/OPTION CARDS

## J9 8229 Scanner Conversion Option Connections

Pin	Function	Pin	Function
1	+V Channel A1	13	+I Channel A1
2	-V Channel A1	14	-I Channel A1
3	+V Channel A2	15	+I Channel A2
4	-V Channel A2	16	-I Channel A2
5	+V Channel A3	17	+I Channel A3
6	-V Channel A3	18	-I Channel A3
7	+V Channel A4	19	+I Channel A4
8	-V Channel A4	20	-I Channel A4
9	Shield	21	B0 LSB
10	Shield	22	B1 Out
11	Shield	23	B2 MSB
12	Shield	24	Digital Grnd

Use the normal connector for the first A input. Even though the Input A contacts are not on the J9 connector, the sensor signal from Input A is routed through the 8229 Scanner.

In essence, the 8229 routes the sensor signals from all five Input A channels to the A Sensor Input Card. The A1 through A4 8229 inputs are designed for four lead measurements and have independent pairs of current and voltage leads. The current leads have a make-before-break switching action and the voltage leads are break-before-make. The B0 through B2 outputs on J9 are a BCD representation of the channel selected with B0 being the least significant bit and B2 the most significant bit (*a 0 represents logic LO and a 1 logic HI with respect to the Digital Ground on J9*). Logic 000 represents channel A0, 001 channel A1, 010 channel A2, 011 channel A3 and 100 represents channel A4 on B2, B1 and B0 respectively.

# THE MODEL DRC-91CA TEMPERATURE CONTROLLER INPUT/OPTION CARDS

## Installation

The 8229 Scanner Conversion is factory installed if ordered with an DRC-93CA Temperature Controller or can be field installed at a later date. If field installation is required, use the following procedure.

**WARNING** To prevent shock hazard, turn off the instrument and disconnect it from AC line power and all test equipment before removing cover.

1. Set the POWER switch to off and disconnect the power cord from the unit.
2. Remove the six screws on the sides of the top enclosure half and lift the cover off.
3. The calibration cover will now be seen.
4. Remove the calibration cover by taking out the six screws on the top of the cover. (see page 2-5) Also, remove the two screws in the center of the rear panel of the instrument located near the top. Lift the cover off.
5. Remove the cover/blanking plate over the J9 connector opening by placing a small flat head screw driver between the back panel and the securing clips. Turn the screw driver until the plastic retainer pins break off. Make certain that both retaining clips are removed from inside of the unit.
6. Install the sensor expansion cable into the J9 opening on the back panel with the supplied hardware. The connector should be installed from the outside of the back panel with the ribbon cable passing through the J9 opening.
7. Install the 8229 scanner card into option slot 3 (SL3 on the main board).
8. Plug the sensor expansion cable into the large connector on the 8229 scanner card.
9. Disconnect the A0 sensor input cable from the A input card and plug this cable into the matching connector on the 8229 scanner card.
10. Plug the 8229 scanner output cable into the A input card (*where you just disconnected the A0 sensor input cable from*).
11. Route the cables along the back panel as to prevent them from being pinched or bound against the calibration cover.
12. Replace the calibration cover and top enclosure half.

# THE MODEL DRC-91CA TEMPERATURE CONTROLLER INPUT/OPTION CARDS

---

## Operation

Operation of the 8229 Scanner Conversion can be implemented either locally, from the front panel, or remotely through the remote interfaces.

### Local 8229 Operation

The 8229 A1 through A4 channels are accessed locally by pressing and holding the sensor button and using the up or down arrow depending on which of the displays you want to change (*A is now channel A0 if the 8229 is present.*). In this mode, the channels will increment in the following manner for the control channel: **A0, 1, 2, 3, 4, B**. Where 1 - 4 correspond to A1 to A4. When changing the channel of the display sensor, there are only two selections **B** and which ever channel the control is set to **A0** through **A4**.

### Channel Dwell Times

The dwell times for the A1 through A4 channels are selected the same as for A and B.

### Units

The units for the A1 through A4 channels are the same as for Input A and are defined by the A Input Card.

### Resolution

Resolution is by input card and not channel. Consequently, resolution is the same for all scanner channels.

#### NOTE

*It is highly recommended that when an 8229 scanner card is used, that the A0 through A4 be used as the sample sensor only. If an input card is installed in the B channel, it is recommended that the B input be used for the control sensor. The reason for this is that when A0 through A4 are changed, there is a momentary loss of control voltage. This loss of control voltage causes the unit to lose it's analog PID voltages and will cause extreme instabilities in the temperature control until the system can once again stabilize.*

## Curve Selection

The 8229 is considered an internal Remote Position. The A0 through A4 channels are interpreted as Remote Position A00 through A04 for curve selection when the SENSOR A ID Switch 4 is OPEN (0).

## Calibration

There is no Calibration required.

## Unpacking Your Model DRC-91CA

Inspect the shipping container for damage. If the shipping container is damaged or the cushioning material inside is stressed, keep them until you have checked the shipment for completeness and proper operation (*following procedures outlined in this manual*). Keep all packing material in case of return.

If components are missing from your shipment, or if there is mechanical damage or defect (apparent or concealed), notify Lake Shore. If the shipping container or cushioning material shows signs of stress, notify the carrier as well as Lake Shore. Keep the shipping materials for inspection by the carrier.

### Included Accessories

1 AC Line Cord (120 VAC)	
2 Sensor Input Mating Connectors (5-pin)	106-233
1 Monitor Output Mating Connector (7-pin)	106-012
1 Auxiliary Fuse Holder	110-020

### Additional Accessories

**RM-3F Rack Mounting Kit** - Mounts unit in a standard 19 inch instrument rack.

#### Cables

- **8072 IEEE-488 Interface Cable** - This cable is one meter long and is equipped with double ended connectors to allow interconnection in serial or star patterns.
- **8271-04 Scanner Sensor Cable** - This cable is three meters long and brings out leads for the four additional input sensors provided by the 8229 Option.
- **8271-21 Sensor/Heater Cable** - This cable is a six pair individually shielded cable with two, 5-pin miniature plugs which mate with the SENSOR A and SENSOR B connectors on the rear panel of the unit. In addition, this cable has a dual banana plug for heater output and a single banana plug for the heater output shield.
- **8271-22 Sensor/Heater/Output Cable** - Consists of two discrete cables. The first is a six pair individually shielded cable with two 5-pin miniature plugs which mate with the SENSOR A and SENSOR B connectors on the rear panel of the unit. In addition, it has a dual banana plug for heater output and a single banana plug for the heater output shield. The second cable is a three pair overall shielded cable for the Monitors Output.

#### Cartridge Heaters

- **50 ohm** - 3/8" in diameter by 1" in length. Rated at 50 watts.
- **25 ohm** - 3/8" in diameter by 1" in length. Rated at 25 watts.

### Return Procedure

If the Model DRC-91CA appears to be operating incorrectly, contact Lake Shore or a factory representative for a Returned Goods Authorization (RGA) number. Instruments may not be accepted without an RGA number. Attach a tag with the following information when returning:

- RGA number
- Instrument model and serial number
- User's name, company, address and phone number
- Malfunction symptoms

Wrap instrument in a protective bag and use original spacers to protect controls. Repack the system in the LSCI shipping carton (if available) and seal it with strong paper or nylon tape. Affix shipping labels and "FRAGILE" warnings. Write the RGA number on the outside of the shipping container or on packing slip.

This section contains information necessary to maintain the Model DRC-91CA. General maintenance, fuse replacement, line voltage selection and calibration are contained here.

## General Maintenance

Clean the DRC-91CA periodically to remove dust, grease and other contaminants. Use the following procedure:

1. Clean the front and rear panels and case with a soft cloth dampened with a mild detergent and water solution.

### NOTE

*DO NOT use aromatic hydrocarbons or chlorinated solvents to clean the unit. They may react with the plastic materials used in the unit or the silk screen printing on the back panel.*

2. Clean the surface of the printed circuit boards (PCBs) using clean, dry air at low pressure.

## Fuse Replacement

The line fuse is accessible from the rear of the unit without opening the case. Use the following procedure to check and/or replace the fuse:

### WARNING

**To prevent shock hazard, turn off the instrument and disconnect it from AC line power and all test equipment before replacing the fuse.**

1. Set the POWER switch to OFF and disconnect the power cord from the unit. The fuse compartment will not open with power cord in place. The fuse compartment is located just to the right of the power cord socket in the power connector assembly.
2. Open the fuse compartment by prying open the cover with a small screw driver from the right side of the assembly.
3. Remove the lower fuse holder by sliding it out of its position with the aid of the small screw driver.

### CAUTION

**For continued protection against fire hazard, replace only with the same type and rating of fuse as specified for the line for the line voltage selected.**

4. Replace the fuse as the table indicates below.

Select	Range (VAC)	Fuse (A)
100	90-105	2 - SB
120	108-126	2 - SB
220	198-231	1 - SB
240	216-252	1 - SB

5. Replace fuse holder in the lower fuse position. Make sure the Line Voltage Selection wheel is in place with the proper line voltage facing out. Close fuse compartment and connect power cord.

## SERVICE AND CALIBRATION

---

### **Line Voltage Selection**

The rear-panel, three-pronged line power connector permits the DRC-91CA to be connected to 100, 120, 220, or 240 VAC line voltages. Use the following procedure to change the line voltage.

**WARNING** To prevent shock hazard, turn off the instrument and disconnect it from AC line power and all test equipment before changing the line voltage selection.

1. Set the POWER switch to OFF and disconnect the power cord from the unit. The fuse compartment will not open with power cord in place. The fuse compartment is located just to the right of the power cord socket in the power connector assembly.
2. Open the fuse compartment by prying open the cover with a small screw driver from the right side of the assembly.
3. Do not rotate the voltage selector wheel while it is in place. Remove the voltage selector wheel and replace it with the proper voltage facing out. Note that the wheel can only be inserted with the voltage read from the left and top.
4. Install the proper fuse as outlined in *Fuse Replacement* listed above.



## SERVICE AND CALIBRATION

### Operational Checks

#### Test Connector

A test connector for the rear panel J1 INPUT A or J2 INPUT B connector to simulate a sensor input is required for operational checks of the DRC-91CA/DRC-93CA. The test connector can be made by taking one of the mating connectors supplied with the unit and configuring a resistor to simulate the temperature sensor in the two wire configuration described on page 2-4. The test resistors specified in the Input Card Characteristics Table below are used in the operational checks.

**Input Card Characteristics Table**

Sensor Input	Sensor Type	Temp. Range & Units Range	Sensor Current	Input A/D Resolution	Input A/D Accuracy	Test Resistor	Display in Sensor Units	Standard Curves	Display with Std. Curves (K)
8210 9210-3 9220-3	Silicon Diodes	1.4-475K 0-2.9999V	1 $\mu$ A	0.05mV	$\pm$ 0.18mV	100k $\Omega$ 0.01%	1.0000V	DRC-D(00) DRC-E1(01) CRV 10(02) CRV 10(04)	71.79 71.42 87.77 87.77
9210-6 9220-6	GaAlAs Diodes	1.4-325K 0-6.5535	10 $\mu$ A	0.1mV	$\pm$ 0.36mV	100k $\Omega$ 0.01%	1.0000V	no std. curve see note 3	
8219-P2 9220-P2	100 $\Omega$ Pt RTD	14-800K 0-299.99 $\Omega$	1mA	0.005 $\Omega$	$\pm$ 0.02 $\Omega$	100 $\Omega$ 0.01%	100.0 $\Omega$	Din 43760 (03)	273.1
8219-P3 9220-P3	1000 $\Omega$ Pt RTD	14-800K 0-2999.9 $\Omega$	0.1mA	0.05 $\Omega$	$\pm$ 0.2 $\Omega$	1000 $\Omega$ 0.01	1000 $\Omega$	Din 43760 (03)	273.1
8219-R1 9220-R1	RhFe RTD	14-800K 0-99.999 $\Omega$	3mA	0.003 $\Omega$	$\pm$ 0.02 $\Omega$	10 $\Omega$ 0.01	10.00 $\Omega$	no std. curve see note 3	
9317C see note 4	Ge CGR	0.3-100K see note 1 1.4-325K 1-10,000 $\Omega$	see note 2	1 in 10 <sup>4</sup>	$\pm$ 0.1% 1-1000 $\Omega$ $\pm$ 0.5% 1-10k $\Omega$	100 $\Omega$ 0.01%	100.00 $\Omega$	no std. curve see note 3	
9318C see note 4	Ge CGR	1.4-100K see note 1	see note 2	1 in 10 <sup>4</sup>	$\pm$ 0.05% 10-10,000 $\Omega$ $\pm$ 0.25% 10-100k $\Omega$	100 $\Omega$ 0.01%	100.00 $\Omega$	no std. curve see note 3	
9215-15	CS-401	0-15.000nF 0-30.000nF	5KHz	0.001nF	$\pm$ 0.25% full scale	N/A	N/A	see note 5	
9215-150	CS-501	0-150.00nF	1KHz	0.01nF	$\pm$ 0.25% full scale	N/A	N/A		
9305	chromel- AuFe .07 &.03%, E,K,T	see page for temp. range -10 to +10mV -15 to +15mV uncomp.	N/A	1 $\mu$ V	$\pm$ 3 $\mu$ V for -10 to +10mV $\pm$ 5 $\mu$ V for -15 to +15mV	0 $\Omega$	uncomp. 0.000mV	see page 3-11	

note 1: The lower temperature limit is dependent upon resistance-temperature characteristic of sensor used.

note 2: 0.1 $\mu$ A to 1.0mA. Sensor voltage pinned at 1mV (9317C) or 10mV (9318C).

note 3: To read correctly in temperature, these input cards must be used with calibrated sensors and the 8001 precision option.

note 4: The 9317C and 9318C will read to 1 $\Omega$  full scale with reduced accuracy.

note 5: The 9215 cards only display in nF.

## SERVICE AND CALIBRATION

### Operational Test Procedure

The operational test procedure is used to verify the overall operation of the DRC-91CA and as a periodic maintenance check. The equipment below is used in the test.

**Digital Voltmeter**      4½ digit resolution or better.  
**Test Connector**        fabricated per previous page

Complete the following set-up procedure:

1. Plug the connector into INPUT A.
2. Connect the DVM across the test resistor of Input A.
3. Connect the DRC-91CA to line power and turn the unit ON. Verify that the DRC-91CA initializes to the proper POWER-ON state.

**NOTE**      *The unit should be allowed a one-hour warm-up time to achieve rated specifications.*

### Current Source Check

The next procedure is used to test the overall DRC-91CA operation. The DVM across the test resistor should read as follows:

Card	Resistor	Voltage
9210/20-3	100kΩ	1.0000V ±100μV
9210/20-6	100kΩ	1.0000V ±100μV
9220-P2	100Ω	0.10000V ±10μV
9220-P3	1000Ω	0.10000V ±10μV
9220-R1	10Ω	0.03000V ±10μV
9317C	100Ω	N/A
9318C	100Ω	N/A
9305	0Ω	0mV
9215	N/A	N/A

### Monitor Voltage

The voltage across the sensor or test resistor is also available on the monitor plug. The connections are given in Section 2 of this manual. The monitor voltage will be equal to the sensor voltage for Silicon Diode (-3) inputs and all platinum (-P2, -P3) and rhodium iron (-R1) inputs. If the input is a GaAlAs Diode (-6) input then the monitor voltage will be 0.458 times the sensor voltage. This test is not applicable for the 9215, 9305, 9317C or 9318C sensor input cards.

## SERVICE AND CALIBRATION

---

### Temperature Display

#### Determine Input Type

The first step is to determine the type of sensor input.

- a. The type of input option card(s) installed in the unit is listed on the second page of this manual.
- b. The DRC-91CA displays the type of sensor input card(s) installed in the A and B inputs sequentially when the instrument is powered on.
- c. The type of input can also be displayed by holding down the LOCAL key.

#### Check units display

Verify that the A units can be changed by holding in the UNITS key and using the ▲▲ key or the ▼▼ key to scroll through the sequence K, C, F, V, K, etc. (Note: the unit goes to V for a diode configuration 9210-3, -6 or 9220-3, -6) or for a resistance card configuration (9220-P2, -P3, -R1 or 9317C/ 9318C Sensor Input card).

#### Check sensor units reading

Next, check to see if the instrument is reading the correct sensor units (volts, ohms or nanofarads) value for the appropriate test resistor or capacitor from Table on page B-3. The reading should match the value given in the Display in Sensor Units column. The allowable error is provided in the Input A/D Accuracy column.

#### Check Temperature Reading

Confirm that the temperature displayed in kelvin corresponds to the selected curve number.

- a. Check the Sensor Curve Table on page 3-11 to determine the curve number that selects the standard curve or precision option that is needed. *(A 9215 card will not read temperature. The 9317C/9318C will not read accurately in temperature unless a precision option is present.)*
- b. Select the curve as described in Section 3.

#### Check Input B

Change the connector from J1 INPUT A to J2 INPUT B. Repeat the process above by verifying the current source and the A/D settings for this input as well as the units change.

## SERVICE AND CALIBRATION

---

### Heater Output Test

#### Heater Output Conditions

The heater should output power when the setpoint temperature is above the display temperature, as long as the heater is on and a gain value has been entered. If the sensor is a diode, the voltage across the device will change inversely with temperature. Therefore, the higher the voltage, the lower the temperature. For Platinum sensors, the resistance increases as the temperature increases. Germanium and carbon glass sensors are negative temperature coefficient resistance sensors which vary several orders of magnitude in resistance with temperature.

#### Test Setup

Test the heater by placing an appropriate test resistor into the control sensor input, and place a 10 ohm (at least 10 watts) up to 25 ohm (at least 25 watts) resistor across the heater terminals.

#### The Heater Display Test With a 10 Ohm Heater

The heater display is shipped from the factory reading the percent of full scale power out. At 100 percent output, the heater will have 1 amp through it and 10 volts across it. If the heater bar graph is reading 50%, then the instrument is delivering 5 watts (0.707 amps and 7.07 volts) to the 10 ohm load. If the unit is reading in current, a reading of 50 will mean 2.5 watts (0.5 amps and 5 volts). The heater display can be changed from power to current by switching internal dip switch S4-1 (see page 2-5).

### Checking Gain, Reset and Rate

Check the operation of the Gain, Rate and Reset as follows:

1. Place a test resistor into the selected sensor input. (Refer to Input Card Characteristic Table on page B-3. Check the Test Resistor Column.) For the 9305 Input Card, short V<sup>+</sup> to V<sup>-</sup>. Use a 10nF capacitor for 9215 Input Card.
2. Place a 10 ohm, 10 watt (or greater) resistance load on the heater terminals.
3. Set the Display Units to Sensor Units. (i.e., volts, ohms or nanofarads) Set a setpoint slightly lower for negative coefficient sensors for slightly higher for positive coefficient sensors.

#### Gain

Turn on the Gain pot. The heater display should now indicate that power is being delivered to the heater. The amount of power is a scaled factor of the error signal times the gain ( $[\text{Sensor voltage} - \text{Setpoint voltage}] * \text{Gain}$ ). If the setpoint error is increased or the gain is increased, the output power will increase.

Remove the cover (see page 2-5). Place the LO lead of the DVM at TP1 and move the HI lead to TP29. Turn off the Gain, Rate and Reset. The DVM will now read approximately 0.0 volts. Change the Gain and the DVM will scale with the Gain setting. Setting the Gain to 99 will result in a reading of approximately 7.2 volts (full scale).

## SERVICE AND CALIBRATION

---

### **Reset**

Enter a gain and setpoint value that results in less than full power to the load. If a Reset value is now entered, the instrument will try to integrate out the error. With a test resistor in the control sensor input and a fixed setpoint, the error signal will be constant. With a constant error, the Reset will continue to increase the analog output control signal until the heater display reads 100 percent. If the heater output increases to approximately 100 percent for these conditions, the reset circuit is operating.

To check the Reset circuit in more detail, use the same set point and a Gain of 10. Move the HI lead of the DVM to TP30 and enter a Reset of 1.0. The reading on the DVM should gradually integrate to approximately 7.2 volts. The time required will depend on the amount of reset with time required being the shortest for higher settings. Next, turn the Reset off and make sure that the reading returns to 0.0 volts.

### **Rate**

The operation of the Rate can not be observed without measuring voltages in the unit. To check the Rate, move the DVM HI lead to TP31, keep the Gain at 10, turn the Reset off (0.0) and enter a Rate to 99. The DVM should read 0.0 volts. Quickly change the set point value from approximately equal to the display value to a value 20% higher in equivalent kelvin temperature (e.g. from 1.00 volts to 0.80 volts). The DVM should show a peak value between 0.1 and 0.4 volts depending on the amount of gain and the speed at which you change the voltage. For the change from .80 to 1.00, the reading will be negative in value.

The Gain, Rate and Reset values are summed together before the heater drive circuit with the Gain being multiplied by two in signal strength before summation. The sum of the three terms can be measured at TP28 ANA OUT.

## **Checking the Heater Ranges**

### **Standard Output**

Set up the unit so that 100 percent is output to the heater load. At full power out on the Max scale, 1 amp should be through the resistor as long as the resistor is 25 ohms or less. The heater circuit has a compliance voltage limit of 25 volts. If the next lower range (-1) is selected, then the heater will put 0.33 amperes through the resistor at 100 percent. The -2 range will output 0.10 amperes at full scale output. At the -3 range, the output will be 0.033 amperes full scale.

### **W50 Watt Option**

This is the same as the Standard Output discussed above except it is for 50 volt compliance, up to a 50 ohm load.

### **W60 Watt Option**

If the unit has a W60 output option, the Max scale has a 1.55 amp, 39 volt limit. If a 25 ohm resistor is used, the controller will supply 60 watts to the load. The lower ranges are scaled as explained above except the voltage limit is 39 volts.

### **NOTE**

*The values given above are nominal values. If they are slightly off it should not effect operation since the heater circuit is part of a feedback loop.*

## SERVICE AND CALIBRATION

---

### Calibration

The adjustments and test points referred to in this section are labeled on the instrument calibration cover.

**WARNING** To prevent shock hazard, turn off the instrument and disconnect it from AC line power and all test equipment before removing cover.

1. Set the POWER switch to off and disconnect the power cord from the unit.
2. Remove the 6 screws on the sides of the top enclosure half and lift the cover off.
3. The calibration cover will now be seen.

**NOTE** The unit should be allowed a one-hour warm-up time to achieve rated specifications. This calibration procedure is for a DRC-91CA with standard diode A and B inputs. For other configurations, refer to Section VII for the specific Input Card present in the unit.

### Input Card Calibration

Calibrate each input card as specified for that card in Section 5.

### Set Point Voltage Calibration

Calibrate the Set Point Voltage as follows:

1. Calibrate with the Control Switch selecting either a 9210 or 9220 Input Card in the -3 configuration. If the unit does not contain one of these input cards, calibrate the set point by following the procedure described with that Input Card.
2. To calibrate the Set Point voltage with a 9210 or 9220 card, connect the LO lead of your DVM to TP1 and the HI lead to TP25 SP V.
3. Enter a set point of 0.0000V and adjust the potentiometer labeled SP ZERO ADJ until the DVM reads 0.0000 volts.
4. Enter a set point of 2.2000V and adjust the potentiometer labeled SP SPAN ADJ until the DVM reads -2.2000 volts.
6. Repeat the two settings until the values are constant.

## SERVICE AND CALIBRATION

### Calibration of Power Output

If the heater output is not the standard 25 watts for the unit, the optional power output installed should be indicated on the second page of this manual.

1. Verify that the load resistor is between 10 and 25 ohms with a wattage rating equivalent to its resistance, standard 50 ohms for 50 watts. The W60 output requires a load between 10 and 25 ohms with a wattage rated 1.5 times the resistance value.

Set a set point and gain value which results in full scale output on the -1 Heater Range scale.

2. With full power across the load resistor on the -1 scale, place the DVM LO probe in TP19 PWR V+ and the DVM HI probe in TP21 and adjust PWR V+ until the DVM reads 1.000 volts. There now should be one ampere through the load (*1.5 amperes in the case of the W60*) with the heater on MAX Range. The heater can now be turned off.
3. Place the DVM LO into TP15 PWR V- and the DVM HI into TP17 PWR V+ and adjust PWR V- ADJ until the DVM reads 0.0000 volts.

#### NOTE

*TP 24 CNT V is the control voltage. For the 9210/20-3 it is the voltage across the sensor; for the 9210/20-6 it is 0.45 times the voltage across the sensor. TP 25 is the set point voltage and is of opposite polarity from TP 24. These two voltages algebraically sum together to create the error signal.*

## ERROR CODE SUMMARY

C

The error codes for the DRC-91CA are separated into categories. The Err0x codes are for mainframe error conditions, the Err1x codes are for interface error conditions and the Err2x codes are for input cards. If an Err0x, an OL or an Err2x occurs for an input selected as the control input, the heater range is taken to OFF and must be reset following correction of the fault condition. The following is a summary of the error codes.

Error Code	Possible Cause/Corrective Action
Err01	The unit encountered an unwritable NOVRAM data location. When this error occurs, the unit displays the error, stores it in the WS data location and halts operation. The NOVRAM initialization sequence should be performed to try to correct the problem. If the error code still exists, the NOVRAM needs to be replaced.
Err02	The unit performs a NOVRAM check on power-up. If the unit detects a NOVRAM data error ( <i>or if the interface XR&amp;I* function was performed</i> ) the unit displays the error, stores it in the WS data location and waits for the NOVRAM initialization sequence to be performed. Repeated Err02 conditions could signal a failure by the NOVRAM to retain data and it should be replaced. To correct this error, open the instrument as described on page 2-5. Turn on the power and close switch 8 of S4. Leave closed for at least 5 seconds and then open. The instrument should now operate normally.
Err09	The REMOTE SENSOR ID for the unit allows for an input range of 00 ( <i>00000 on bits B4 through B0 of the ID</i> ) to 1E ( <i>11110 on bits B4 through B0</i> ). The 1F input is reversed for a REMOTE SENSOR ID error condition ( <i>the Position Data Adaptor uses this code to indicate that more than one Sensor Scanner is active to the unit</i> ). When the error occurs, it is stored in the WS data location and continues to monitor the REMOTE SENSOR ID until the fault is corrected.
Err10	8223 RS-232C Interface Parity Error. The error may be caused by problems with the signal lines or incorrectly specified parity. The error, and any of the other DRC91-RS errors, is transmitted when the unit is asked to output and is cleared following the first transmission after the error.
Err11	8223 RS-232C Interface Overrun Error. The error is caused by the unit's main processor not reading the input character before the next one becomes available. The overrun character(s) are lost.
Err12	8223 RS-232C Interface Framing Error. The error may be caused by signal line transients or incorrectly specified stop bits or character length.
Err13	8223 RS-232C Interface Input Buffer Overrun Error. This error occurs when more than 256 characters are input to the FIFO buffer of the unit. Any characters received after the 256th character are lost.



## ERROR CODE SUMMARY

Error Code	Possible Cause/Corrective Action
OL	Input Overload. When an input signal ( <i>which exceeds the maximum allowed for that input</i> ) is applied the error occurs. When the error occurs, the displays indicate OL if it is the DISPLAY SENSOR input and stores OL in the WS and/or the WC data locations.
Err20	9317C/9318C Input Card Error. The 9317C and 9318C Input Cards have an EEPROM that stores the calibration constants used to set the sensor current and determine the resulting voltage accurately. When the card detects an error in the EEPROM storage, it tries to correct it. If it cannot correct the error, it transmits the Err20 code to the main processor and resets the sensor current to the lowest value to avoid any potential sensor damage. The unit displays the error, stores it in the WS data location and halts operation. The Input Card calibration procedure should be performed to try to correct the problem. If the error code still exists, the Input Card EEPROM needs to be replaced.
Err25	Unrecognized A Input Card Type. The 92xx series cards and "Smart" (microprocessor controlled) Input Cards tell the main processor what card type they are. The error could be caused by the Input Card not being present or if the card had a selection switch de-selected ( <i>e.g., if it were not pressed correctly or came out of detent in shipping</i> ). When the error occurs, the unit displays dashes (----) if it is the DISPLAY SENSOR input and continues operation until the fault is corrected. The error is stored in the WI A Input data location and is displayed when the LOCAL key is pressed to determine the Input Card Type.
Err26	Unrecognized B Input Card Type. Operation is the same as Err25 except the error is stored in the WI B Input data location.
Err27	Incorrect A Input polarity. The 92xx series Input Cards determine if the input signal polarity doesn't match the temperature coefficient of the sensor type selected. There is either an error in the sensor wiring an open circuit or a fault on the Input Card. When the error occurs, the unit displays the error if it is the DISPLAY SENSOR input and continues operation until the fault is corrected. The error is stored in the WI A Input data location and is displayed when the LOCAL key is pressed to determine the Input Card Type.
Err28	Incorrect B Input Card Polarity. Operation is the same as Err27 except the error is stored in the WI B Input data location

# CURVE TABLES

**D**

## Standard Diode and Platinum Curves

Breakpoint Number	D CURVE		E1 CURVE		DT-470 CURVE 10		Platinum 100 Ohm	
	Temp.(K)	V	Temp.(K)	V	Temp.(K)	V	Temp.(K)	$\Omega$
1	499.9	0.00000	499.9	0.00000	499.9	0.00000	000.0	0.00000
2	365.0	0.19083	330.0	0.28930	475.0	0.09032	030.0	0.03820
3	345.0	0.24739	305.0	0.36220	460.0	0.12536	032.0	0.04235
4	305.0	0.36397	285.0	0.41860	435.0	0.18696	036.0	0.05146
5	285.0	0.42019	265.0	0.47220	390.0	0.29958	038.0	0.05650
6	265.0	0.47403	240.0	0.53770	340.0	0.42238	040.0	0.06170
7	240.0	0.53960	220.0	0.59260	280.0	0.56707	042.0	0.06726
8	220.0	0.59455	170.0	0.73440	230.0	0.68580	046.0	0.07909
9	170.0	0.73582	130.0	0.84490	195.0	0.76717	052.0	0.09924
10	130.0	0.84606	100.0	0.92570	165.0	0.83541	058.0	0.12180
11	090.0	0.95327	075.0	0.99110	140.0	0.89082	065.0	0.15015
12	070.0	1.00460	060.0	1.02840	115.0	0.94455	075.0	0.19223
13	055.0	1.04070	040.0	1.07460	095.0	0.98574	085.0	0.23525
14	040.0	1.07460	036.0	1.08480	077.4	1.02044	105.0	0.32081
15	034.0	1.09020	034.0	1.09090	060.0	1.05277	140.0	0.46648
16	032.0	1.09700	032.0	1.09810	044.0	1.08105	180.0	0.62980
17	030.0	1.10580	030.0	1.10800	036.0	1.09477	210.0	0.75044
18	029.0	1.11160	029.0	1.11500	031.0	1.10465	270.0	0.98784
19	028.0	1.11900	028.0	1.12390	028.0	1.11202	315.0	1.16270
20	027.0	1.13080	027.0	1.13650	027.0	1.11517	355.0	1.31616
21	026.0	1.14860	026.0	1.15590	026.0	1.11896	400.0	1.48652
22	025.0	1.17200	025.0	1.18770	025.0	1.12463	445.0	1.65466
23	023.0	1.25070	024.0	1.23570	024.0	1.13598	490.0	1.82035
24	021.0	1.35050	022.0	1.33170	020.0	1.21555	535.0	1.98386
25	017.0	1.63590	018.0	1.65270	015.5	1.29340	585.0	2.16256
26	015.0	1.76100	013.0	1.96320	012.0	1.36687	630.0	2.32106
27	013.0	1.90660	009.0	2.17840	009.0	1.44850	675.0	2.47712
28	009.0	2.11720	004.0	2.53640	003.8	1.64112	715.0	2.61391
29	003.0	2.53660	003.0	2.59940	002.0	1.68912	760.0	2.76566
30	001.4	2.59840	001.4	2.65910	001.4	1.69808	800.0	2.89830
31	000.0	6.55360	000.0	6.55360	000.0	6.55360	999.9	6.55360

## CURVE TABLES

### Thermocouple Curves

Breakpoint Number	Chromel vs. Au-0.03 at.% Fe		Chromel vs. Au-0.07 at.% Fe	
	Temp(K)	V <sub>TC</sub> (mV)	Temp(K)	V <sub>TC</sub> (mV)
1	0.0	-15.0000	0.0	-15.0000
2	3.5	-4.6676	1.4	-5.2982
3	8.0	-4.6067	3.0	-5.2815
4	13.5	-4.5259	4.8	-5.2594
5	18.0	-4.4571	7.0	-5.2285
6	24.0	-4.3703	10.5	-5.1742
7	30.0	-4.2869	19.0	-5.0315
8	52.0	-3.9928	26.0	-4.9126
9	60.0	-3.8830	48.0	-4.5494
10	65.0	-3.8126	58.0	-4.3810
11	70.0	-3.7411	70.0	-4.1733
12	80.0	-3.5948	80.0	-3.9952
13	90.0	-3.4436	90.0	-3.8132
14	105.0	-3.2026	100.0	-3.6270
15	115.0	-3.0374	110.0	-3.4370
16	125.0	-2.8689	120.0	-3.2435
17	135.0	-2.6957	135.0	-2.9477
18	145.0	-2.5184	150.0	-2.6452
19	160.0	-2.2468	165.0	-2.3372
20	170.0	-2.0615	180.0	-2.0242
21	180.0	-1.8725	200.0	-1.6004
22	195.0	-1.5839	220.0	-1.1693
23	210.0	-1.2905	245.0	-0.6232
24	225.0	-0.9912	270.0	-0.0705
25	240.0	-0.6847	300.0	+0.5986
26	265.0	-0.1670	305.0	+0.7158
27	275.0	+0.0378	310.0	+0.8431
28	285.0	+0.2387	315.0	+0.9944
29	305.0	+0.6350	320.0	+1.1940
30	325.0	+1.0387	325.0	+1.4841
31	999.9	+15.0010	999.9	+15.0010

## CURVE TABLES

### Thermocouple Curves

Breakpoint Number	Chromel vs. Constantan Temp(K)	E V <sub>TC</sub> (mV)	Chromel vs. Alumel Temp(K)	K V <sub>TC</sub> (mV)	Copper vs. Constantan Temp(K)	T V <sub>TC</sub> (mV)
1	0.0	-15.0000	0.0	-15.0000	0.0	-15.0000
2	3.0	-9.8355	3.0	-6.4582	3.0	-6.2584
3	5.6	-9.8298	6.0	-6.4551	6.5	-6.2523
4	9.0	-9.8182	10.0	-6.4486	11.0	-6.2401
5	13.5	-9.7956	14.5	-6.4376	16.5	-6.2184
6	19.0	-9.7570	19.5	-6.4205	22.0	-6.1888
7	25.0	-9.7013	25.0	-6.3951	29.0	-6.1404
8	32.0	-9.6204	32.0	-6.3529	38.0	-6.0615
9	40.0	-9.5071	40.0	-6.2913	48.0	-5.9535
10	50.0	-9.3366	48.0	-6.2149	60.0	-5.7995
11	60.0	-9.1345	58.0	-6.1022	75.0	-5.5753
12	70.0	-8.9030	65.0	-6.0099	90.0	-5.3204
13	80.0	-8.6475	75.0	-5.8634	105.0	-5.0337
14	90.0	-8.3673	85.0	-5.6989	120.0	-4.7194
15	105.0	-7.9064	95.0	-5.5156	135.0	-4.3767
16	120.0	-7.3943	105.0	-5.3166	155.0	-3.8781
17	135.0	-6.8386	120.0	-4.9881	175.0	-3.3278
18	150.0	-6.2400	135.0	-4.6240	195.0	-2.7342
19	170.0	-5.3831	150.0	-4.2267	220.0	-1.9295
20	190.0	-4.4564	165.0	-3.7994	245.0	-1.0586
21	210.0	-3.4702	185.0	-3.1866	270.0	-0.1254
22	235.0	-2.1605	205.0	-2.5259	300.0	+1.0616
23	260.0	-0.7666	230.0	-1.6463	330.0	+2.3247
24	290.0	+0.9948	260.0	-0.5186	360.0	+3.6639
25	320.0	+2.8428	295.0	+0.8688	395.0	+5.3095
26	350.0	+4.7704	350.0	+3.1298	430.0	+7.0419
27	385.0	+7.1149	395.0	+4.9999	470.0	+9.1113
28	420.0	+9.5570	460.0	+7.6164	510.0	+11.2758
29	460.0	+12.4425	510.0	+9.6125	555.0	+13.8053
30	475.0	+13.5573	575.0	+12.2790	575.0	+14.9685
31	999.9	+15.0010	999.9	+15.0010	999.9	+15.0010

## **DRC-91C and DRC-91CA Setpoint Resolution Update**

The DRC-91C has gone through some changes in the past few months. The new model is called the DRC-91CA because of improvements in hardware design. The instrument software has also been updated to address specific customer requests. The most noticeable software change is in the setpoint display.

The controller will now display the control setpoint past the tenths place in temperature. This users manual does not reflect that change. The hundredths place is displayed and settable with the keys on the front panel or over the remote interface. In many applications (*especially at low temperatures*), the enhanced display resolution is usable by the controller in computing a control point. However, hardware limitations with the setpoint setting DAC in the DRC-91C and DRC-91CA make it impossible to use the full display resolution of the setpoint at all times.

The following examples demonstrate when the higher resolution setpoint is usable and why the controller will sometimes ignore small changes in the setpoint. A table is included to show usable resolution for some typical sensors.

These examples will show how setpoint display resolution is related to actual changes in the hardware control point for a silicon diode. The setpoint setting DAC has 15 bits of resolution and must cover the 3 volt range of a silicon diode sensor. The smallest step change that the DAC can make is  $[3V/2^{15}=92\mu V]$ .

### **Example 1**

The sensitivity of a silicon diode at 200K is typically 2mV/K. The 92 $\mu$ V (0.092mV) step size of the setpoint DAC translates to a temperature change of  $[0.092mV / (2mV/K) = 0.046K]$ . Because of this, a setpoint display change of less than 0.05K would not be guaranteed to change the control point.

### **Example 2**

The sensitivity of a silicon diode sensor at 20K is typically better than 20mV/K. The 92 $\mu$ V step size of the setpoint DAC now translates to  $[0.092mV / (20mV/K) = 0.0046K]$ . This is well below the 0.01K setpoint display resolution. Therefore, the full resolution of the display is usable in this temperature range.

**Smallest Recognized Change In Setpoint  
for Typical Sensors**

Silicon Diode	<30K >30K	.01K .05K
GaAlAs Diode	<30K >30K	.01K .09K
Platinum	40-100K >100K	.03K .04K
Rhodium Iron	40-100K >100K	.08K .04K
CGR and Germanium	<60K >60K	.01K NA
Ch-AuFe .07% Thermocouple	4-325K	.06K

## ***Using the New Setpoint Resolution***

The new software works on both the DRC-91C and DRC-91CA. No changes or modifications are required after the new software PROM is properly installed in the instrument.

The new setpoint format is automatically available. It does not have to be turned on or off. The front panel arrow keys are used to enter the setpoint as described in the users manual with the digits shifted one place to the right.

Computer interface operation is very consistent with the previous software so user programs DO NOT have to change. The setpoint can be entered exactly as before. For example, sending a setpoint of 100.1 over the computer interface will cause a setpoint of 100.10 to appear on the display. The instrument will understand and use the low resolution form of the setpoint. When reading the setpoint from the instrument, the same exact number of characters will be sent. Now the character before the units character will be the hundredths digit instead of the blank that was sent previously.

# INDEX

<b>A</b>		
Accessories .....	A-1	
Address Codes .....	4-5	
Application Notes .....	E-1	
<b>B</b>		
Bench Use .....	2-6	
Bus Control Commands .....	4-6, 4-7	
<b>C</b>		
Calibration .....	B-8	
Input Card Calibration		
Setpoint Voltages Calibration		
Calibration Of Power Output		
Command Table Of Contents .....	4-1	
Control Commands .....	4-21	
Control Parameters .....	3-7, 3-8	
Control Queries .....	4-24	
Control Sensor .....	3-5	
Control Sensor Display Resolution .....	3-5	
Control Sensor Input Channel .....	3-5	
Control Sensor Units .....	3-5	
Control Setpoint .....	1-4	
Curve Commands .....	4-29	
Curve Display .....	3-10	
Curve Queries .....	4-32	
Curve Selection .....	3-10	
Curve Selection With Curves 00-15 .....	3-10	
Curve Selection With Curves Higher Than 15 .....	3-12	
Curve Table (sensor) .....	3-11	
Curve Tables .....	D-1 -- D-3	
Curves With 8229 Scanner Option .....	3-13	
Curves With External Scanners .....	3-14	
<b>D</b>		
Device Specific Commands .....	4-8	
Display Sensor .....	3-4	
Display Sensor Display Resolution .....	3-4	
Temperature Resolution		
Voltage Resolution		
Resistance Resolution		
Capacitance Resolution		
Display Sensor Input Channel .....	3-4	
Display Sensor Units .....	3-4	
<b>E</b>		
Environmental Requirements .....	2-2	
Error Codes .....	C-1, C-2	
Errors .....	3-3	
<b>F</b>		
Filter Function .....	3-6	
Front Panel Graphic .....	1-6	
Fuse Replacement .....	B-1	
<b>G</b>		
Gain .....	3-7, 3-8, 4-9	
General Maintenance .....	B-1	
Grounding and Shielding .....	2-2	
<b>H</b>		
Heater Display .....	2-3	
Heater Power Output .....	1-4	
Heater Output Ranges .....	2-3, 3-7	
Heater Setup .....	2-3	
<b>I</b>		
IEEE-488 Address Switch .....	4-3, 4-4	
IEEE-488 Commands .....	4-6, 4-9	
IEEE-488 Interface .....	4-2	
IEEE Specifications .....	4-2	
Input Cards .....	1-3, 5-1 -- 5-31	
9210 .....	1-3, 5-2 -- 5-4	
9215 .....	1-3, 5-16 -- 5-22	
9220 .....	1-3, 5-5 -- 5-7	
9305 .....	1-3, 5-23 -- 5-31	
9317C/9318C .....	1-3, 5-8 -- 5-15	
Input Card Configurations .....	3-2, 3-3, 5-1	
Input/Option Card Installation .....	2-5	
Interface Capabilities .....	4-2	
Interface Commands .....	4-10	
Interface Queries .....	4-12	
Interfaces .....	1-4	
<b>L</b>		
Line Voltage Selection .....	2-2, B-2	
<b>M</b>		
Memory .....	1-3, 3-3	
Multiline Commands .....	4-6	
<b>O</b>		
Operating Temperature .....	2-2	
Operational Checks .....	B-3	
Test Connector		
Operational Test Procedure		
Current Source Check		
Monitor Voltage		
Temperature Display		
Heater Output Test		
Checking Gain, Rate and Reset		
Checking Heater Ranges		
Option Cards .....	1-4, 5-32 -- 5-48	
8223 .....	1-4, 5-32 -- 5-41	
8225 .....	1-4, 5-42 -- 5-44	
8229 .....	1-4, 5-45 -- 5-48	

# INDEX

---

## P

Position Feature .....	3-12
Curve Numbers Higher Than 15 .....	3-12
Position# Versus Curve # Table .....	3-12
Display of Curves .....	
Power Requirements .....	2-2
Power Up Sequence .....	3-2
Power Up Status .....	3-3
Precision Options .....	1-2

## R

Rack Mounting .....	2-6
Rate .....	3-7, 3-8, 4-9
Remote Sensor ID .....	3-14
Reset .....	3-7, 3-8, 4-9
Return Procedure .....	A-1

## S

S4 .....	2-3, 2-5, 3-3
Sample Programs .....	4-34
Scan Commands .....	4-18
Scan Dwell Time .....	3-6
Scan Function .....	3-6
Scan Queries .....	4-20
Sensor ID Switches .....	3-9, 4-9
Sensor Input Connections .....	2-4
Sensor Output Monitors .....	2-5
Sensors .....	1-2
Serial Interface .....	4-9
Setpoint .....	3-7
Software Installation .....	2-5
Specifications .....	1-5
Status Registers .....	4-25, 4-26

## T

Talker and/or Listener Configuration .....	4-3
Terminating Characters .....	4-3
Thermometry Commands .....	4-13
Thermometry Queries .....	4-16

## U

Uniline Commands .....	4-6
Universal Commands .....	4-6